

Engineering Software

# GX Works2 Version 1 Operating Manual (Structured Project)

---

-SW1DNC-GXW2-E

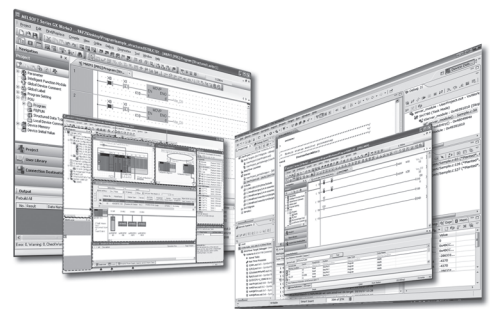



# ● SAFETY PRECAUTIONS ●

(Always read these instructions before using this product.)

Before using this product, thoroughly read this manual and the relevant manuals introduced in this manual and pay careful attention to safety and handle the products properly.

The precautions given in this manual are concerned with this product. For the safety precautions of the programmable controller system, refer to the User's Manual for the CPU module.

In this manual, the safety precautions are ranked as "⚠️ WARNING" and "⚠️ CAUTION".



Indicates that incorrect handling may cause hazardous conditions, resulting in death or severe injury.



Indicates that incorrect handling may cause hazardous conditions, resulting in minor or moderate injury or property damage.

Note that the ⚠️ CAUTION level may lead to serious consequences according to the circumstances. Always follow the precautions of both levels because they are important for personal safety.

Please save this manual to make it accessible when required and always forward it to the end user.

## [Design Instructions]

### ⚠️ WARNING

- When data change, program change, or status control is performed from a personal computer to a running programmable controller, create an interlock circuit outside the programmable controller to ensure that the whole system always operates safely.  
Furthermore, for the online operations performed from a personal computer to a programmable controller CPU, the corrective actions against a communication error due to such as a cable connection fault should be predetermined as a system.

## [Startup/Maintenance Instructions]

### ⚠️ CAUTION

- The online operations performed from a personal computer to a running programmable controller CPU (Program change when a programmable controller CPU is RUN, operating status changes such as forced input/output operation and RUN-STOP switching, and remote control operation) must be executed after the manual has been carefully read and the safety has been ensured.  
When changing a program while a programmable controller CPU is RUN, it may cause a program corruption in some operating conditions. Fully understand the precautions described in GX Works2 Version 1 Operating Manual (Common) before use.
- The positioning test functions of OPR, JOG, inching or positioning data for QD75/LD75 positioning module must be executed with the programmable controller set to STOP after the manual has been carefully read and the safety has been ensured. Specially when executing the function on the network system, ensure the safety thoroughly since the machinery whose operation cannot be checked by an operator may be activated. The operation failure may cause the injury or machine damage.

# ● CONDITIONS OF USE FOR THE PRODUCT ●

- (1) Mitsubishi programmable controller ("the PRODUCT") shall be used in conditions;
- i) where any problem, fault or failure occurring in the PRODUCT, if any, shall not lead to any major or serious accident; and
  - ii) where the backup and fail-safe function are systematically or automatically provided outside of the PRODUCT for the case of any problem, fault or failure occurring in the PRODUCT.

- (2) The PRODUCT has been designed and manufactured for the purpose of being used in general industries.

MITSUBISHI SHALL HAVE NO RESPONSIBILITY OR LIABILITY (INCLUDING, BUT NOT LIMITED TO ANY AND ALL RESPONSIBILITY OR LIABILITY BASED ON CONTRACT, WARRANTY, TORT, PRODUCT LIABILITY) FOR ANY INJURY OR DEATH TO PERSONS OR LOSS OR DAMAGE TO PROPERTY CAUSED BY the PRODUCT THAT ARE OPERATED OR USED IN APPLICATION NOT INTENDED OR EXCLUDED BY INSTRUCTIONS, PRECAUTIONS, OR WARNING CONTAINED IN MITSUBISHI'S USER, INSTRUCTION AND/OR SAFETY MANUALS, TECHNICAL BULLETINS AND GUIDELINES FOR the PRODUCT.

("Prohibited Application")

Prohibited Applications include, but not limited to, the use of the PRODUCT in;

- Nuclear Power Plants and any other power plants operated by Power companies, and/or any other cases in which the public could be affected if any problem or fault occurs in the PRODUCT.
- Railway companies or Public service purposes, and/or any other cases in which establishment of a special quality assurance system is required by the Purchaser or End User.
- Aircraft or Aerospace, Medical applications, Train equipment, transport equipment such as Elevator and Escalator, Incineration and Fuel devices, Vehicles, Manned transportation, Equipment for Recreation and Amusement, and Safety devices, handling of Nuclear or Hazardous Materials or Chemicals, Mining and Drilling, and/or other applications where there is a significant risk of injury to the public or property.

Notwithstanding the above, restrictions Mitsubishi may in its sole discretion, authorize use of the PRODUCT in one or more of the Prohibited Applications, provided that the usage of the PRODUCT is limited only for the specific applications agreed to by Mitsubishi and provided further that no special quality assurance or fail-safe, redundant or other safety features which exceed the general specifications of the PRODUCTS are required. For details, please contact the Mitsubishi representative in your region.

## REVISIONS

Print date	Manual number*1	Revision
Jul. 2008	SH(NA)-080781ENG-A	First edition
Jan. 2009	SH(NA)-080781ENG-B	<p><b>Model Addition</b> Q00UJ, Q00U, Q01U, Q10UDH, Q10UDEH, Q20UDH, Q20UDEH, FX series</p> <p><b>Addition</b> MANUALS, Section 6.2.7, Appendix 1.4</p> <p><b>Correction</b> GENERIC TERMS AND ABBREVIATIONS IN THIS MANUAL, Section 1.1, Section 1.3.1, Section 1.3.5, Section 1.3.6, Section 4.2, Section 5.3, Section 5.4, Section 5.7, Section 6.1.1, Section 6.2.1, Section 6.2.2, Section 6.2.8, Section 7.1, Section 7.2, Section 7.5, Section 7.5.1, Section 7.6.5, Section 8.1, Section 9.4, Section 9.5, Section 11.2, Appendix 1.1, Appendix 1.5</p>
Jul. 2009	SH(NA)-080781ENG-C	<p><b>Model Addition</b> Q00J, Q00, Q01</p> <p><b>Addition</b> Section 6.4.3, Chapter 7</p> <p><b>Correction</b> MANUALS, GENERIC TERMS AND ABBREVIATIONS IN THIS MANUAL, Section 1.2, Section 1.3, Section 2.1, Section 4.1, Section 4.2.1, Section 4.2.2, Section 4.2.3, Section 4.3.1, Section 4.3.2, Section 4.4.1, Section 5.1, Section 5.2, Section 5.3, Section 5.4, Section 5.6.1, Section 6.1, Section 6.2.1, Section 6.2.3, Section 6.2.4, Section 6.3, Section 6.3.1, Section 6.4, Section 6.4.4, Section 6.4.10, Section 6.4.11, Section 6.4.13, Chapter 8, Section 9.1, Section 11.2, Section 11.3, Section 12.2, Appendix 1</p> <p><b>Modification</b> Section 6.3.4 → Section 7.12, Section 6.4.3 to Section 6.4.12 → Section 6.4.4 to Section 6.4.13, Chapter 7 to Chapter 11 → Chapter 8 to Chapter 12</p>
Oct. 2009	SH(NA)-080781ENG-D	<p><b>Correction</b> MANUALS, GENERIC TERMS AND ABBREVIATIONS IN THIS MANUAL, Section 1.3.1, Section 1.3.6, Section 5.1, Section 5.2, Section 5.3, Section 5.4, Section 6.4.2, Section 6.4.7, Section 12.1, Section 12.2, Appendix 1.2, Appendix 1.6</p>
Jan. 2010	SH(NA)-080781ENG-E	<p><b>Model Addition</b> L02, L26-BT</p> <p><b>Addition</b> CONDITIONS OF USE FOR THE PRODUCT, Section 6.2.11</p> <p><b>Correction</b> MANUALS, GENERIC TERMS AND ABBREVIATIONS IN THIS MANUAL, Section 1.3, Section 2.1, Section 4.1, Section 4.2.3, Section 4.4.1, Section 5.2, Section 5.7, Section 6.2.2, Section 6.4.2, Section 6.4.3, Section 6.4.7, Section 6.4.13, Section 8.1, Section 8.2, Section 8.4.7, Section 9.1, Section 12.1, Section 12.2, Appendix 1</p> <p><b>Modification</b> Section 6.2.11 → Section 6.2.12</p>
Apr. 2010	SH(NA)-080781ENG-F	<p><b>Model Addition</b> Q50UDEH, Q100UDEH, LJ72GF15-T2</p> <p><b>Correction</b> MANUALS, GENERIC TERMS AND ABBREVIATIONS IN THIS MANUAL, Section 1.2, Section 1.3.1, Section 2.1, Section 5.2, Section 5.3, Section 5.4, Section 5.5, Section 5.7, Section 8.1, Section 8.2, Section 8.4.3, Section 8.5, Section 11.1, Section 12.2, Appendix 1.1, Appendix 1.2, Appendix 1.6, Appendix 1.8</p>
Sept. 2010	SH(NA)-080781ENG-G	<p><b>Addition</b> Section 5.8</p> <p><b>Correction</b> Section 1.2, Section 1.3.1, Section 4.3.2, Section 4.4.1, Section 5.2, Section 5.3, Section 5.4, Section 5.7, Section 6.2.1, Section 6.2.2, Section 6.2.10, Section 6.4.2, Section 6.4.7, Section 8.1, Section 8.2, Section 8.5, Section 9.1, Section 12.1, Section 12.2, Appendix 1.1, Appendix 1.2, Appendix 1.6</p>

Print date	Manual number*1	Revision
Jan. 2011	SH(NA)-080781ENG-H	<p><b>Addition</b> TERMS, Section 5.5.1, Section 5.5.2, Section 6.2.5, Chapter 7, Chapter 8, Section 11.2.3</p> <p><b>Correction</b> MANUALS, GENERIC TERMS AND ABBREVIATIONS IN THIS MANUAL, Section 1.2, Section 1.3.1, Section 2.1, Section 4.2.2, Section 4.2.3, Section 5.2, Section 5.3, Section 5.4, Section 5.5, Section 6.1.1, Section 6.2.1, Section 10.5, Section 11.1, Section 12.1, Section 12.2, Section 14.2, Appendix 1</p> <p><b>Modification</b> Section 5.5.1 to 5.5.2 → Section 5.5.3 to 5.5.4, Section 6.2.2 → Section 7.1.4, Section 6.2.3 → Section 6.2.2, Section 6.2.4 → Section 8.8, Section 6.2.5 → Section 6.2.3, Section 6.2.6 → Section 8.8.7, Section 6.2.7 → Section 8.11, Section 6.2.8 → Section 6.2.4, Section 6.2.10 to 6.2.12 → Section 6.2.6 to 6.2.8, Section 6.3 → Chapter 7, Section 6.4 → Chapter 8, Section 11.2.2 → Section 13.3.1, Section 11.2.3 → Section 13.2.5, Section 11.2.4 → Section 13.3.4, Section 11.2.5 → Section 13.2.2, Section 11.2.6 to Section 11.2.7 → Section 13.3.3, Section 11.2.8 → Section 13.2.6, Section 11.2.9 to Section 11.2.10 → Section 13.2.4, Section 11.2.11 → Section 13.3.5, Section 13.2.7, Chapter 7 to 12 → Chapter 9 to 14</p>
Mar. 2011	SH(NA)-080781ENG-I	<p><b>Addition</b> Section 5.7.1, Section 10.5.1, Section 10.5.2, Section 10.5.3</p> <p><b>Correction</b> MANUALS, Section 1.3.1, Section 5.4, Section 5.7, Section 6.2.1, Section 6.2.2, Section 8.2.2, Section 8.9, Section 8.9.2, Section 10.1, Section 10.2, Section 10.4.4, Section 10.4.6, Section 10.5, Section 11.1, Section 14.2, Appendix 1.1, Appendix 1.6</p>
Jul. 2011	SH(NA)-080781ENG-J	<p><b>Model Addition</b> L02-P, L26-PBT</p> <p><b>Addition</b> Section 8.7.2, Section 8.8.7, Appendix 1.2</p> <p><b>Correction</b> MANUALS, GENERIC TERMS AND ABBREVIATIONS IN THIS MANUALS, GENERIC TERMS AND ABBREVIATIONS IN THIS MANUAL, Section 1.2, Section 1.3.1, Section 1.3.6, Section 2.1, Section 4.3.2, Section 4.4.1, Section 5.2, Section 5.3, Section 5.4, Section 5.6.3, Section 5.7.1, Section 6.1, Section 6.1.2, Section 6.2.1, Section 6.2.6, Section 6.2.7, Section 6.2.8, Section 6.2.9, Section 8.1, Section 8.2.1, Section 8.5.1, Section 8.5.2, Section 8.6.3, Section 8.7.5, Section 8.8.4, Section 8.8.7, Section 8.8.8, Section 8.9.3, Section 8.10, Section 8.11, Section 10.1, Section 10.2, Section 10.4.4, Section 10.5.2, Section 10.5.3, Section 11.1, Section 12.1, Section 12.3.2, Section 12.4, Section 13.3.7, Section 13.4.5, Section 14.1, Section 14.2, Appendix 1.6</p> <p><b>Modification</b> Section 8.7.2 to Section 8.7.4 → Section 8.7.3 to Section 8.7.5, Section 8.8.7 → Section 8.8.8, Appendix 1.2 to Appendix 1.8 → Appendix 1.3 to Appendix 1.9</p>
Sept. 2011	SH(NA)-080781ENG-K	<p><b>Correction</b> Section 1.3.1</p>
Nov. 2011	SH(NA)-080781ENG-L	<p><b>Correction</b> MANUALS, Section 1.3.1, Section 4.1, Section 4.2.1, Section 4.2.3, Section 4.3.2, Section 4.4.1, Section 5.2, Section 5.3, Section 5.4, Section 5.5.3, Section 5.5.4, Section 5.6.1, Section 5.6.3, Section 5.6.4, Section 6.2.1, Section 6.2.2, Section 6.2.4, Section 7.1.1, Section 8.3.5, Section 8.7.1, Section 8.7.4, Section 8.7.5, Section 8.8.3, Section 8.8.5, Section 8.9.2, Section 8.9.3, Section 10.1, Section 10.5.3, Section 10.6, Section 13.2.4, Section 13.3.1, Section 14.1, Section 14.2, Appendix 1.1, Appendix 1.3, Appendix 1.7</p> <p><b>Modification</b> Section 1.3.5 to Section 1.3.6 → Section 1.3.2 to Section 1.3.3, Section 13.2 to Section 13.4 → Section 13.4 to Section 13.3, Appendix 1.3 → Appendix 1.2, Appendix 1.7 → Appendix 1.3</p> <p><b>Deletion</b> Section 1.3.2, Section 1.3.3, Section 1.3.4, Section 13.1, Appendix 1.2, Appendix 1.4, Appendix 1.5, Appendix 1.6, Appendix 1.8, Appendix 1.9</p>

Print date	Manual number*1	Revision
Jan. 2012	SH(NA)-080781ENG-M	<p><b>Model Addition</b> FX3GC</p> <p><b>Correction</b> Section 1.3.1, Section 5.5.4, Section 11.1, Section 14.2</p>
May 2012	SH(NA)-080781ENG-N	<p><b>Model Addition</b> Q02PH, Q06PH, Q12PH, Q12PRH, Q25PH, Q25PRH</p> <p><b>Addition</b> Section 5.5.4</p> <p><b>Correction</b> Section 1.3.1, Section 2.1, Section 3.1, Section 4.2.3, Section 4.4.1, Section 5.2, Section 5.5.3, Section 5.6.1, Section 5.6.3, Section 5.6.4, Section 5.7.1, Section 8.3.3, Section 8.8.7, Section 10.5.3, Section 14.2, Appendix 1.1, Appendix 1.2</p> <p><b>Modification</b> Section 5.5.4 → Section 5.5.5</p>
Sept. 2012	SH(NA)-080781ENG-O	<p><b>Addition</b> Section 5.7, Section 10.4.6</p> <p><b>Correction</b> Section 1.3.1, Section 6.1.2, Section 6.2.8, Section 7.1.4, Section 10.1, Section 10.2, Section 10.5.2, Section 14.1, Section 14.2</p> <p><b>Modification</b> Section 5.7 to Section 5.8 → Section 5.8 to Section 5.9, Section 10.4.6 to Section 10.4.7 → Section 10.4.7 to Section 10.4.8</p>
Feb. 2013	SH(NA)-080781ENG-P	<p><b>Model Addition</b> Q03UDV, Q04UDV, Q06UDV, Q13UDV, Q26UDV, L02S, L06, L26</p> <p><b>Addition</b> Section 5.5.6, Section 10.4.7, Section 12.6</p> <p><b>Correction</b> GENERIC TERMS AND ABBREVIATIONS IN THIS MANUAL, Section 1.3.1, Section 2.1, Section 3.1, Section 4.3.2, Section 4.4.1, Section 6.2.1, Section 10.4.2, Section 12.1.1, Section 13.2.7, Section 14.2, Appendix 1.1, Appendix 1.3</p> <p><b>Modification</b> Section 10.4.7 to Section 10.4.8 → Section 10.4.8 to Section 10.4.9 Section 12.1 → Section 12.1.1 to Section 12.1.2</p>
May 2013	SH(NA)-080781ENG-Q	<p><b>Model Addition</b> L02S-P, L06-P, L26-P, FX3S</p> <p><b>Correction</b> GENERIC TERMS AND ABBREVIATIONS IN THIS MANUAL, Section 2.1, Section 5.5.2, Section 7.1.1, Section 8.2.2, Section 8.4.2, Section 8.4.3, Section 10.5.3, Section 12.6, Section 14.2</p>
Sept. 2013	SH(NA)-080781ENG-R	<p><b>Addition</b> Section 8.7.5</p> <p><b>Correction</b> Section 1.3.3, Section 5.5.6, Section 8.6.1, Section 14.2</p> <p><b>Modification</b> Section 8.7.3 to Section 8.7.5 → Section 8.7.2 to Section 8.7.4</p> <p><b>Deletion</b> Section 8.7.2</p>
Dec. 2013	SH(NA)-080781ENG-S	<p><b>Correction</b> Section 4.1, Section 4.4.1, Section 5.6.4, Section 8.8.5, Section 10.5.3, Section 14.1, Section 14.2</p>

Print date	Manual number*1	Revision
Mar. 2014	SH(NA)-080781ENG-T	<b>Correction</b> Section 4.4.1, Section 5.5.3, Section 5.6.4, Section 10.5.3
Jun. 2014	SH(NA)-080781ENG-U	<b>Correction</b> Section 5.2, Section 5.5.1, Section 10.2, Section 14.1, Section 14.2
Sept. 2014	SH(NA)-080781ENG-V	<b>Correction</b> Section 13.3.5, Appendix 1
Dec. 2014	SH(NA)-080781ENG-W	<b>Correction</b> Section 10.1, Section 10.2
Mar. 2015	SH(NA)-080781ENG-X	<b>Correction</b> Section 10.5, Section 12.1.2, Section 13.3.1, Section 14.2

\*1 : The manual number is written at the bottom left of the back cover.

Japanese Manual Version SH-080732-AG

This manual confers no industrial property rights or any rights of any other kind, nor does it confer any patent licenses. Mitsubishi Electric Corporation cannot be held responsible for any problems involving industrial property rights which may occur as a result of using the contents noted in this manual.

© 2008 MITSUBISHI ELECTRIC CORPORATION



# INTRODUCTION

---

Thank you for purchasing the Mitsubishi integrated FA software, MELSOFT series.  
Before using the product, thoroughly read this manual to develop full familiarity with the functions and performance to ensure correct use.

## CONTENTS

---

SAFETY PRECAUTIONS .....	A - 1
CONDITIONS OF USE FOR THE PRODUCT.....	A - 2
REVISIONS .....	A - 3
INTRODUCTION .....	A - 7
CONTENTS .....	A - 7
MANUALS .....	A - 13
GENERIC TERMS AND ABBREVIATIONS IN THIS MANUAL.....	A - 22
TERMS.....	A - 22

## 1 OVERVIEW

---

1.1	What is Structured Project?	1 - 2
1.2	Features of Structured Project	1 - 2
1.3	List of Functions	1 - 5
1.3.1	List of functions common to Simple project and Structured project .....	1 - 5
1.3.2	List of functions for editing in Structured Text .....	1 - 8
1.3.3	List of functions for editing in Structured Ladder/FBD .....	1 - 9

## 2 SCREEN CONFIGURATION

---

2.1	Overview of Screen Configuration	2 - 2
-----	----------------------------------	-------

## 3 PROGRAMMING PROCEDURE

---

3.1	Creating Programs	3 - 2
-----	-------------------	-------

## 4 PROGRAM CONFIGURATIONS

---

4.1	Program Configurations of Structured Project	4 - 2
4.2	Creating Program Files and Tasks	4 - 3
4.2.1	Procedure for creating program files and tasks .....	4 - 3
4.2.2	Registering program blocks to tasks .....	4 - 4
4.2.3	Setting executing conditions .....	4 - 7
4.3	Creating POUs	4 - 10
4.3.1	Procedure for creating POUs .....	4 - 10

4.3.2	Setting properties of functions and function blocks . . . . .	4 - 11
4.4	Using POUs . . . . .	4 - 14
4.4.1	Using functions and function blocks . . . . .	4 - 15

## 5 SETTING LABELS

---

5.1	The Type of Label Setting Editor . . . . .	5 - 2
5.2	Setting Global Labels . . . . .	5 - 3
5.3	Setting Local Labels for Program Blocks . . . . .	5 - 8
5.4	Setting Labels for Functions and Function Blocks . . . . .	5 - 10
5.5	Common Operations for Setting Labels . . . . .	5 - 12
5.5.1	Classes . . . . .	5 - 12
5.5.2	Data types . . . . .	5 - 13
5.5.3	Selecting data types . . . . .	5 - 14
5.5.4	Label comments . . . . .	5 - 17
5.5.5	Editing rows . . . . .	5 - 17
5.5.6	Deleting unused labels . . . . .	5 - 21
5.6	Setting Structure Labels . . . . .	5 - 23
5.6.1	Setting structures . . . . .	5 - 23
5.6.2	Defining data type of label as structure . . . . .	5 - 24
5.6.3	Assigning devices to structure labels . . . . .	5 - 25
5.6.4	Assigning devices to structure array labels . . . . .	5 - 27
5.7	Checking Duplications of Devices Assigned to Global Labels . . . . .	5 - 30
5.8	Setting Ranges for Devices Assigned Automatically . . . . .	5 - 31
5.8.1	Considerations of automatically assigned devices . . . . .	5 - 32
5.9	Writing/Reading Data to/from CSV Files . . . . .	5 - 34

## 6 COMMON OPERATIONS OF PROGRAM EDITORS

---

6.1	Types of Program Editor . . . . .	6 - 2
6.1.1	Available programming languages . . . . .	6 - 3
6.1.2	Available comment types . . . . .	6 - 4
6.2	Common Operations of Program Editors . . . . .	6 - 5
6.2.1	Using POUs (Element Selection window) . . . . .	6 - 5
6.2.2	Using labels in the program . . . . .	6 - 8
6.2.3	Undo and redo . . . . .	6 - 11
6.2.4	Changing display size of editing screen . . . . .	6 - 11
6.2.5	Splitting editing screen . . . . .	6 - 12
6.2.6	Opening local label setting screen of program editor being edited . . . . .	6 - 13
6.2.7	Displaying compilation result in list format . . . . .	6 - 13
6.2.8	Setting display content of tooltip . . . . .	6 - 14
6.2.9	Opening label setting and program screens for selected POU . . . . .	6 - 15

## 7 EDITING ST PROGRAMS

---

7.1	ST Editor	7 - 2
7.1.1	Writing ST programs	7 - 3
7.1.2	Automatic indention	7 - 3
7.1.3	Setting tab length	7 - 4
7.1.4	Using templates	7 - 5

## 8 EDITING STRUCTURED LADDER/FBD PROGRAMS

---

8.1	Creating Ladder/FBD Programs	8 - 2
8.1.1	Selecting editing modes	8 - 3
8.2	Editing in Select Mode	8 - 4
8.2.1	Entering elements	8 - 4
8.2.2	Entering instructions	8 - 5
8.3	Drawing Lines	8 - 7
8.3.1	Connecting lines automatically when entering elements	8 - 7
8.3.2	Connecting elements with lines	8 - 8
8.3.3	Connecting lines automatically	8 - 8
8.3.4	Overwriting input/output variable with lines	8 - 9
8.3.5	Rearranging lines automatically	8 - 9
8.3.6	Inserting and deleting rows and columns	8 - 10
8.4	Operating Elements	8 - 11
8.4.1	Moving elements	8 - 11
8.4.2	Moving elements with lines connected	8 - 11
8.4.3	Copying elements	8 - 13
8.5	Changing Type of Contact and Coil	8 - 15
8.5.1	Setting the type of contact and coil	8 - 15
8.5.2	Changing contact and coil in predetermined order	8 - 17
8.6	Operating Functions and Function Blocks	8 - 18
8.6.1	Adding variables automatically when entering functions and function blocks	8 - 18
8.6.2	Editing variable names and instance names	8 - 19
8.6.3	Changing the number of arguments for functions and function blocks	8 - 20
8.7	Changing Display Format of Variables	8 - 21
8.7.1	Displaying variable names in multiple lines	8 - 21
8.7.2	Displaying instance names in multiple lines	8 - 22
8.7.3	Specifying the number of displaying characters for variable names	8 - 22
8.7.4	Changing display format of variable	8 - 23
8.7.5	Displaying additional label items	8 - 26
8.8	Editing Ladder Blocks	8 - 27
8.8.1	Inserting ladder blocks	8 - 27
8.8.2	Deleting ladder blocks	8 - 27
8.8.3	Cutting, copying, pasting, and moving ladder blocks	8 - 28
8.8.4	Editing ladder block headers	8 - 29
8.8.5	Editing listed ladder blocks	8 - 30
8.8.6	Setting ladder block labels/titles	8 - 32

8.8.7	Switching to display/hide left power rail . . . . .	8 - 32
8.8.8	Displaying grid . . . . .	8 - 33
8.9	Editing Comments . . . . .	8 - 34
8.9.1	Editing comments . . . . .	8 - 34
8.9.2	Changing the size of comment entry field . . . . .	8 - 34
8.9.3	Moving comments . . . . .	8 - 35
8.10	Editing in Guided Mode . . . . .	8 - 36
8.10.1	Overwrite mode and insert mode . . . . .	8 - 36
8.10.2	Entering elements . . . . .	8 - 37
8.10.3	Entering instructions . . . . .	8 - 37
8.10.4	Connecting elements with lines . . . . .	8 - 37
8.10.5	Drawing lines . . . . .	8 - 38
8.10.6	Wrapping lines . . . . .	8 - 38
8.10.7	Setting Guided mode as the default editing mode . . . . .	8 - 39
8.10.8	Entering variable names after contacts and coils . . . . .	8 - 39
8.10.9	Inserting comment entry fields to ladder blocks to be added . . . . .	8 - 40
8.11	Checking Wrapping Position for Printing . . . . .	8 - 41

## 9 SEARCHING FOR SPECIFIC POSITION

---

9.1	Searching for Specific Position in ST Program . . . . .	9 - 2
9.1.1	Jumping to specified line . . . . .	9 - 2
9.1.2	Using bookmarks . . . . .	9 - 2
9.2	Searching for Specific Position in Structured Ladder/FBD Program . . . . .	9 - 4
9.2.1	Jumping to specified ladder block number . . . . .	9 - 4

## 10 CONVERTING/COMPILING PROGRAMS

---

10.1	Converting/Compiling Created Programs . . . . .	10 - 2
10.2	Compiling All Programs . . . . .	10 - 4
10.3	Executing Online Program Change Simultaneously with Conversion/Compilation . . . . .	10 - 6
10.4	Changing Operating Conditions of Compilation . . . . .	10 - 6
10.4.1	Changing the number of errors and warnings that stop compilation . . . . .	10 - 6
10.4.2	Hiding warning messages . . . . .	10 - 7
10.4.3	Using same name for global label and local label . . . . .	10 - 8
10.4.4	Using same lower case label name as device . . . . .	10 - 8
10.4.5	Connecting PLS, PLF, or ALT outputs directly to other inputs with lines . . . . .	10 - 9
10.4.6	Using VAR_OUTPUT for an argument of function block . . . . .	10 - 10
10.4.7	Assigning temporary arguments for arguments when calling function block . . . . .	10 - 10
10.4.8	Assigning common devices to outputs of function with EN/ENO . . . . .	10 - 11
10.4.9	Retaining bit type outputs of functions . . . . .	10 - 14
10.5	Compilation . . . . .	10 - 15
10.5.1	Compilation target data when compiling all programs . . . . .	10 - 15
10.5.2	Assigning devices . . . . .	10 - 16
10.5.3	Considerations of Compilation . . . . .	10 - 19

10.6	Checking for Errors and Warnings	10 - 23
10.6.1	Correcting errors and warnings	10 - 24

## 11 WRITING/READING DATA TO/FROM PROGRAMMABLE CONTROLLER CPU

---

11.1	Writing/Reading Data to/from Programmable Controller CPU	11 - 2
------	--	--------

## 12 MONITORING

---

12.1	Starting and Stopping Monitoring Programs	12 - 2
12.1.1	Starting monitoring programs	12 - 2
12.1.2	Stopping monitoring programs	12 - 3
12.2	Starting and Stopping Monitoring Function Blocks	12 - 4
12.3	Changing Operating Conditions of Monitoring	12 - 5
12.3.1	Changing current value display format (decimal/hexadecimal) of word type variable	12 - 5
12.3.2	Setting the number of displaying characters for character strings	12 - 6
12.4	Monitoring Programs on ST Editor	12 - 7
12.5	Monitoring Programs in Structured Ladder/FBD Editor	12 - 9
12.6	Setting Monitoring Conditions	12 - 11

## 13 USING USER LIBRARIES

---

13.1	Procedure for Using User Library	13 - 2
13.2	Creating User Library	13 - 3
13.2.1	Creating user libraries	13 - 3
13.2.2	Changing library name	13 - 4
13.2.3	Creating data	13 - 4
13.2.4	Saving library file	13 - 5
13.2.5	Deleting user library from project	13 - 7
13.2.6	Setting password to user library	13 - 8
13.2.7	Set help file to library	13 - 9
13.3	Using User Library	13 - 10
13.3.1	Installing user library data to project	13 - 10
13.3.2	Creating programs using user library	13 - 12
13.3.3	Editing user library	13 - 13
13.3.4	Updating user library	13 - 15
13.3.5	Displaying user library help	13 - 16

## 14 SETTING OPTIONS

---

14.1	Basic Operations	14 - 2
14.2	Option Setting List	14 - 3

## APPENDIX

---

Appendix 1	List of Toolbars and Shortcut Keys	App - 2
Appendix 1.1	Common toolbars and shortcut keys . . . . .	App - 2
Appendix 1.2	Toolbar icons and shortcut keys for setting labels . . . . .	App - 4
Appendix 1.3	Toolbar icons and shortcut keys for program editors . . . . .	App - 5

## INDEX

---

## ■ MANUALS

Related manuals are separately issued according to the purpose of their functions in GX Works2.

### ● Related manuals

The manuals related to this product are shown below.  
Refer to the following tables when ordering required manuals.

#### 1) Operation of GX Works2

Manual name	Manual number (Model code)
GX Works2 Version 1 Operating Manual (Common) Explains the system configuration of GX Works2 and the functions common to Simple project and Structured project such as parameter setting, operation method for the online function. (Sold separately)	SH-080779ENG (13JU63)
GX Works2 Version 1 Operating Manual (Simple Project) Explains methods for such as creating and monitoring programs in Simple project of GX Works2. (Sold separately)	SH-080780ENG (13JU64)
GX Works2 Version 1 Operating Manual (Simple Project, Function Block) Explains methods for such as creating function blocks, pasting function blocks to sequence programs, and operating FB library in Simple project of GX Works2. (Sold separately)	SH-080984ENG (13JU72)
GX Works2 Version 1 Operating Manual (Intelligent Function Module) Explains methods of intelligent function module for such as parameter setting, monitoring programs, and predefined protocol support function in GX Works2. (Sold separately)	SH-080921ENG (13JU69)
GX Works2 Beginner's Manual (Simple Project) Explains fundamental methods for such as creating, editing, and monitoring programs in Simple project for users inexperienced with GX Works2 (Sold separately)	SH-080787ENG (13JZ22)
GX Works2 Beginner's Manual (Structured Project) Explains fundamental methods for such as creating, editing, and monitoring programs in Structured project for users inexperienced with GX Works2. (Sold separately)	SH-080788ENG (13JZ23)

#### 2) Structured Programming

Manual name	Manual number (Model code)
MELSEC-Q/L/F Structured Programming Manual (Fundamentals) Explains the programming methods, types of programming languages, and other information required to create structured programs. (Sold separately)	SH-080782ENG (13JW06)
MELSEC-Q/L Structured Programming Manual (Common Instructions) Explains the specifications and functions of common instructions such as sequence instructions, basic instructions, and application instructions that can be used in structured programs. (Sold separately)	SH-080783ENG (13JW07)
MELSEC-Q/L Structured Programming Manual (Application Functions) Explains the specifications and functions of application functions that can be used in structured programs. (Sold separately)	SH-080784ENG (13JW08)
MELSEC-Q/L Structured Programming Manual (Special Instructions) Explains the specifications and functions of special instructions such as module dedicated instruction, PID control instruction, and built-in I/O function dedicated instruction, that can be used in structured programs. (Sold separately)	SH-080785ENG (13JW09)
FXCPU Structured Programming Manual [Device & Common] Explains the devices and parameters provided in GX Works2 for structured programming. (Sold separately)	JY997D26001 (09R925)
FXCPU Structured Programming Manual [Basic & Applied Instruction] Explains the sequence instructions provided in GX Works2 for structured programming. (Sold separately)	JY997D34701 (09R926)

Manual name	Manual number (Model code)
FXCPU Structured Programming Manual [Application Functions] Explains the application functions provided in GX Works2 for structured programming. (Sold separately)	JY997D34801 (09R927)

### 3) Operation of iQ Works

Manual name	Manual number (Model code)
Let's start iQ Works Version 2 Explains fundamental methods for such as managing the system using MELSOFT Navigator and using system labels for users inexperienced with GX Works2. (Sold separately)	SH-081261ENG (13JZ79)

#### *Point*

The Operating Manuals are included on the CD-ROM of the software package in a PDF file format. Manuals in printed form are sold separately for single purchase. Order a manual by quoting the manual number (model code) listed in the table above.





● **Purpose of this manual**

This manual explains the operations for creating sequence programs in Structured project using the functions supported by GX Works2.











Manuals for reference are listed in the following table according to their purpose.

For information such as the content and number of each manual, refer to the list of 'Related manuals'.

**1) Installation of GX Works2 and USB driver**















Purpose	GX Works2 Installation Instructions	GX Works2 Version 1 Operating Manual
		Common
Learning the operating environment and installation method		
Learning a USB driver installation method		

**2) Operation of GX Works2**

Purpose	GX Works2 Beginner's Manual		GX Works2 Version 1 Operating Manual				
	Simple Project	Structured Project	Common	Simple Project		Structured Project	Intelligent Function Module
					Function Block		
Learning all functions of GX Works2							
Learning the project types and available languages in GX Works2							
Learning the basic operations and operating procedures when creating a simple project for the first time							
Learning the basic operations and operating procedures when creating a structured project for the first time							
Learning the operations of available functions regardless of project type.							
Learning the functions and operation methods for programming							
Learning the operations and operating procedures when creating function blocks (FB) in Simple project.							
Learning data setting methods for intelligent function module							







### 3) Operations in each programming language









For details of instructions used in each programming language, refer to the section 4 and the section 5 on the following pages.

Purpose		GX Works2 Beginner's Manual		GX Works2 Version 1 Operating Manual	
		Simple Project	Structured Project	Simple Project	Structured Project
Simple Project	Ladder Diagram				
	Sequential Function Chart				
	Structured Text				
Structured Project	Ladder Diagram				
	Sequential Function Chart				
	Structured Ladder /FBD				
	Structured Text				











\*1 : MELSP3 and FX series SFC only

4) Details of instructions in each programming language (for QCPU (Q mode)/LCPU)

Purpose		MELSEC-Q/L/F Structured Programming Manual	MELSEC-Q/L Structured Programming Manual			MELSEC-Q/L Programming Manual	MELSEC-Q/L/QnA Programming Manual		Manual for module to be used
		Fundamentals	Common Instructions	Special Instructions	Application Functions	Common Instruction	PID Control Instructions	SFC	-
All languages	Learning details of programmable controller CPU error codes, special relays, and special registers								
Using Ladder Diagram	Learning the types and details of common instructions								
	Learning the types and details of instructions for intelligent function modules								
	Learning the types and details of instructions for network modules								
	Learning the types and details of instructions for the PID control function								
Using Sequential Function Chart	Learning details of specifications, functions, and instructions of SFC (MELSAP3)								

Purpose		MELSEC-Q/L/F Structured Programming Manual	MELSEC-Q/L Structured Programming Manual			MELSEC-Q/L Programming Manual	MELSEC-Q/L/QnA Programming Manual		Manual for module to be used
		Fundamentals	Common Instructions	Special Instructions	Application Functions	Common Instruction	PID Control Instructions	SFC	-
Using Structured Ladder/ FBD or Structured Text	Learning the fundamentals for creating a structured program								
	Learning the types and details of common instructions								
	Learning the types and details of instructions for intelligent function modules								
	Learning the types and details of instructions for network modules								
	Learning the types and details of instructions for the PID control function								
	Learning the types and details of application instructions								

### 5) Details of instructions in each programming language (for FXCPU)

Purpose		MELSEC-Q/L/F Structured Programming Manual	FXCPU Structured Programming Manual			FXCPU Programming Manual		
		Fundamentals	Device & Common Instructions	Basic & Applied Instruction	Application Functions	FX0,FX0S, FX0N,FX1, FX2,FX2C	FX1S,FX1N, FX2N,FX1NC, FX2NC	FX3S, FX3G,FX3U, FX3GC,FX3UC
Using Ladder Diagram	Learning the types and details of basic/ application instructions, descriptions of devices and parameters							
Using Sequential Function Chart	Learning details of specifications, functions, and instructions of SFC							
Using Structured Ladder/ FBD or Structured Text	Learning the fundamentals for creating a structured program							
	Learning the descriptions of devices, parameters, and error codes							
	Learning the types and details of sequence instructions							
	Learning the types and details of application instructions							

● How to read this manual

**Supported CPU**  
Supported programmable controller CPUs are shown in icons under the section title.

**Chapter heading**  
Index on the right of the page number clarifies the chapter of currently open page.

8.1 Creating Ladder/FBD Programs

## 8.1 Creating Ladder/FBD Programs

Q CPU L CPU FX

This section explains how to create ladder programs and functions for creating ladder programs on the structured ladder/FBD editor.  
The structured ladder/FBD editor is a language editor in graphic format for creating programs in the structured ladder/FBD language.  
Ladder symbols such as contacts, coils, and functions/function blocks are used to create structured ladder/FBD programs. Each ladder symbol is connected with a line.  
The suitable editing mode can be selected according to the program entry method and editing target. (Section 8.1.1)

**Screen display**

Select Project view ⇒ "POU" ⇒ "Program" ⇒ "(program)" ⇒ "Program".

**Display contents**

Name	Description	Reference
Ladder block	A unit for creating a program. A ladder block consists of a ladder block header and a program editing area.	Section 8.8
Ladder block header	Display information such as a title set for each ladder block, and a label name of the jump target.	Section 8.8.4
Program editing area	An area for creating a program. Ladder symbols can be placed in the grid area.	Section 8.1
Left power rail	A start position of the structured ladder program. For FBD, the display of left power rail can be switched to hide. Indicate specific positions of tab stop and start/end positions of lines.	Section 8.8.8

**Screen display**  
Describes the screen display procedure. Follow the ⇒ and select [(menu)] to open the screen. \*Screen display may differ depending on the CPU type. In that case, typical example is described.

**Display contents**  
Describes the display contents on the screen.

**Operating procedure**  
Describes the operating procedure of the function.

**Reference location**  
☞ leads to the reference location and reference manual.

**Screen button**  
Describes the buttons on the screen.

**Section title**  
Clarifies the section of currently open page.

**Operating procedure**

- Set the items on the screen.
- When the cursor is placed on a setting item, an explanation of the item is displayed in the "Explanation" field.

**Screen button**

- Back to System Default**  
Restores the initial settings.
- Back to User Default**  
Restores the user default settings.
- Set as User Default**  
Stores the current settings as the user default and applies them to a new project.

12 - 2

1 OVERVIEW  
 2 SCREEN CONFIGURATION  
 3 PROGRAMMING PROCEDURE  
 4 PROGRAM CONFIGURATIONS  
 5 SETTING LABELS  
 6 PROGRAMMING OF PROGRAM EDITOR  
 7 EDITING OF SCREEN DISPLAYS  
 8 EDITING STRUCTURED LADDER/FBD PROGRAMS

The following table explains the CPU module icons that indicate the function availability.

Icon			Description
QCPU (Q mode)	LCPU	FXCPU	
			Normal icons indicate that the corresponding function is available.
	-	-	Icons with * (asterisk) symbol indicate that the corresponding function is available with restrictions such as CPU types.
			Icons with symbol × indicate that the corresponding function is not available.

This manual also uses the following columns:

**Point!**

This indicates notes for requiring attention or useful functions relating to the information given on the same page.

**Restrictions!**

This indicates restrictions relating to the information given on the same page.

● **Symbols used in this manual**

The following shows the symbols used in this manual with descriptions and examples.

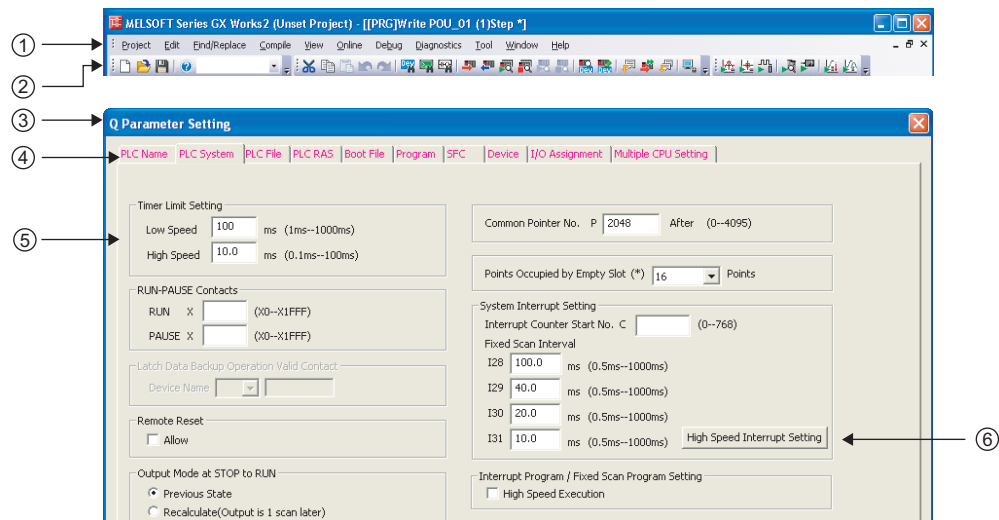

No.	Symbol	Description	Example
①	[ ]	Menu name on a menu bar	[Project]
②		Toolbar icon	
③	<u>(Underline)</u>	Screen name	<u>Q Parameter Setting</u> screen
④	<< >>	Tab name on a screen	<<PLC System>>
⑤	" "	Item name on a screen	"Timer Limit Setting"
⑥		Button on a screen	
-		Keyboard key	

## ■ GENERIC TERMS AND ABBREVIATIONS IN THIS MANUAL

The following are the generic terms/abbreviations of such as software packages and programmable controller CPUs used in this manual.

Generic term and abbreviation	Description
GX Works2	Generic product name for SWnDNC-GXW2-E (n: version)
Existing application	-
GX Developer	Product name for SWnD5C-GPPW-E, SWnD5C-GPPW-EA, SWnD5C-GPPW-EV, and SWnD5C-GPPW-EVA (n: version)
GX IEC Developer	Product name for SWnD5C-MEDOC3 (n: version)
MELSOFT Navigator	Product name for the integrated development environment included in SWnDNC-IQWK (MELSOFT iQ Works) (n: version)
iQ Works	Abbreviation for MELSOFT iQ Works
Personal computer	Generic term for personal computer on which Windows® operates
Basic model QCPU	Generic term for Q00J, Q00, and Q01
High Performance model QCPU	Generic term for Q02, Q02H, Q06H, Q12H, and Q25H
Process CPU	Generic term for Q02PH, Q06PH, Q12PH, and Q25PH
Redundant CPU	Generic term for Q12PRH and Q25PRH
Universal model QCPU	Generic term for Q00UJ, Q00U, Q01U, Q02U, Q03UD, Q03UDE, Q03UDV, Q04UDH, Q04UDEH, Q04UDV, Q06UDH, Q06UDEH, Q06UDV, Q10UDH, Q10UDEH, Q13UDH, Q13UDEH, Q13UDV, Q20UDH, Q20UDEH, Q26UDH, Q26UDEH, Q26UDV, Q50UDEH, and Q100UDEH
High-speed Universal model QCPU	Generic term for Q03UDV, Q04UDV, Q06UDV, Q13UDV, and Q26UDV
QCPU (Q mode)	Generic term for Basic model QCPU, High Performance model QCPU, Process CPU, Redundant CPU, and Universal model QCPU
LCPU	Generic term for L02S, L02S-P, L02, L02-P, L06, L06-P, L26, L26-P, L26-BT, and L26-PBT
FXCPU	Generic term for FX0S, FX0, FX0N, FX1, FX1S, FX1N, FX1NC, FXU, FX2C, FX2N, FX2NC, FX3S, FX3G, FX3GC, FX3U, and FX3UC
FXGP (WIN)	Abbreviation for SW0PC-FXGP/WIN-E
MELSAP3	Abbreviation for the SFC function in MELSAP3 display format
MELSAP-L	Generic term for the SFC function in MELSAP-L (instruction format) and MELSAP-L (start conditions format)
SFC	Generic term for MELSAP3, MELSAP-L, and FX series SFC

## ■ TERMS

The following are the terms used in this manual.

Term	Description
Simple project	Generic term for projects created by using Ladder Diagram/Sequential Function Chart/Structured Text
Structured project	Generic term for projects created by using Ladder Diagram/Sequential Function Chart/Structured Text/Structured Ladder/FBD
Common instruction	Generic term for sequence instructions, basic instructions, application instructions, data link instructions, multiple CPU dedicated instructions, and multiple CPU high-speed transmission dedicated instructions
Special instruction	Generic term for module dedicated instructions, PID control instructions, socket communication function instructions, built-in I/O function instructions, and data logging function instructions
List format	An input format to input mnemonic language in a ladder program





# 1 OVERVIEW

This manual explains specific operating procedures using Structured project.  
For the full product features and functions of GX Works2, refer to the following manual.  
☞ GX Works2 Version 1 Operating Manual (Common)

1.1	What is Structured Project?	1 - 2
1.2	Features of Structured Project	1 - 2
1.3	List of Functions	1 - 5

## 1.1 What is Structured Project?

In Structured project, programs can be created using the structured programming.

By segmenting the control functions and creating components from commonly used parts of programs, this type of programming (structured programming) is easy to understand visually, and created components are highly reusable to other programs.

## 1.2 Features of Structured Project

This section explains the features of Structured project.

### ■ Various programming languages are available

Various programming languages are available for structured programs. Users can combine these languages by selecting the most appropriate programming language for each purpose to create programs.

Language	Description
Ladder Diagram (LD)*1	A graphic language using ladders composed of contacts and coils. Can be operated in a similar way to existing GX Developer operation.
Structured Text (ST)	A high-level structured text language with grammatical structure similar to C language.
Sequential Function Chart (SFC)*1	A graphic language in which executing orders and executing conditions of programs are defined.
Structured Ladder	A graphic language using ladders composed of contacts and coils, which can be inserted flexibly.
Function Block Diagram (FBD)	A graphic language using ladders by connecting functions and/or function blocks with lines.

\*1 : Not supported by FXCPU.

### ■ Common program editors for each programmable controller CPU

The program editors of Structured project can be used for any type of programmable controller CPU supported by GX Works2. Users can select the desired programming languages regardless of the target programmable controller CPU.

For details of the programmable controller CPUs supported by GX Works2, refer to the following manual.

 GX Works2 Version 1 Operating Manual (Common)

## ■ Creating large programs efficiently with structured programming

In Structured project, programs can be easily structured by managing program components in a hierarchy.\*1

Programs that are easy to maintain and highly reusable can be created efficiently by structuring programs. This is suitable for developing large programs.

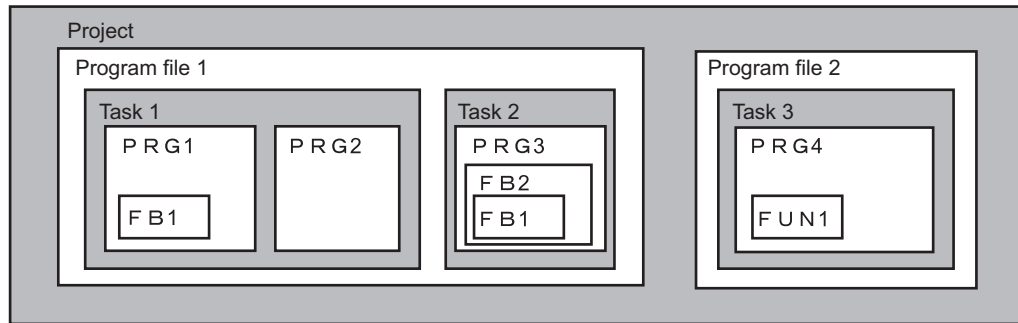

\*1 : A program is created in units of POUs (abbreviation for Program Organization Units) such as program blocks (PRGs), functions (FUNs), and function blocks (FBs). Function blocks can be nested in a hierarchy. Created programs are registered to the tasks of program files.

## ■ Assets of programs are utilized as libraries

In Structured project, sequence program components can be saved as libraries which can be utilized as assets of programs in multiple projects.

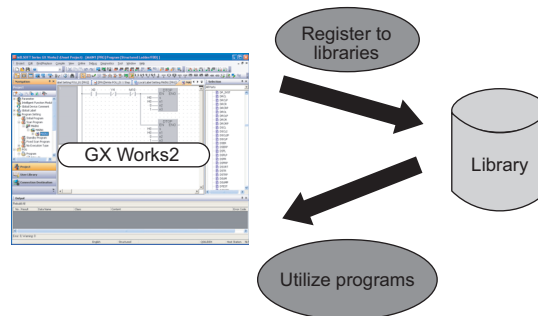

## ■ Assets of past programs can be utilized

In GX Works2, sequence programs created with previous versions of GX Developer and GX IEC Developer can be imported, which enables efficient utilization of program assets.

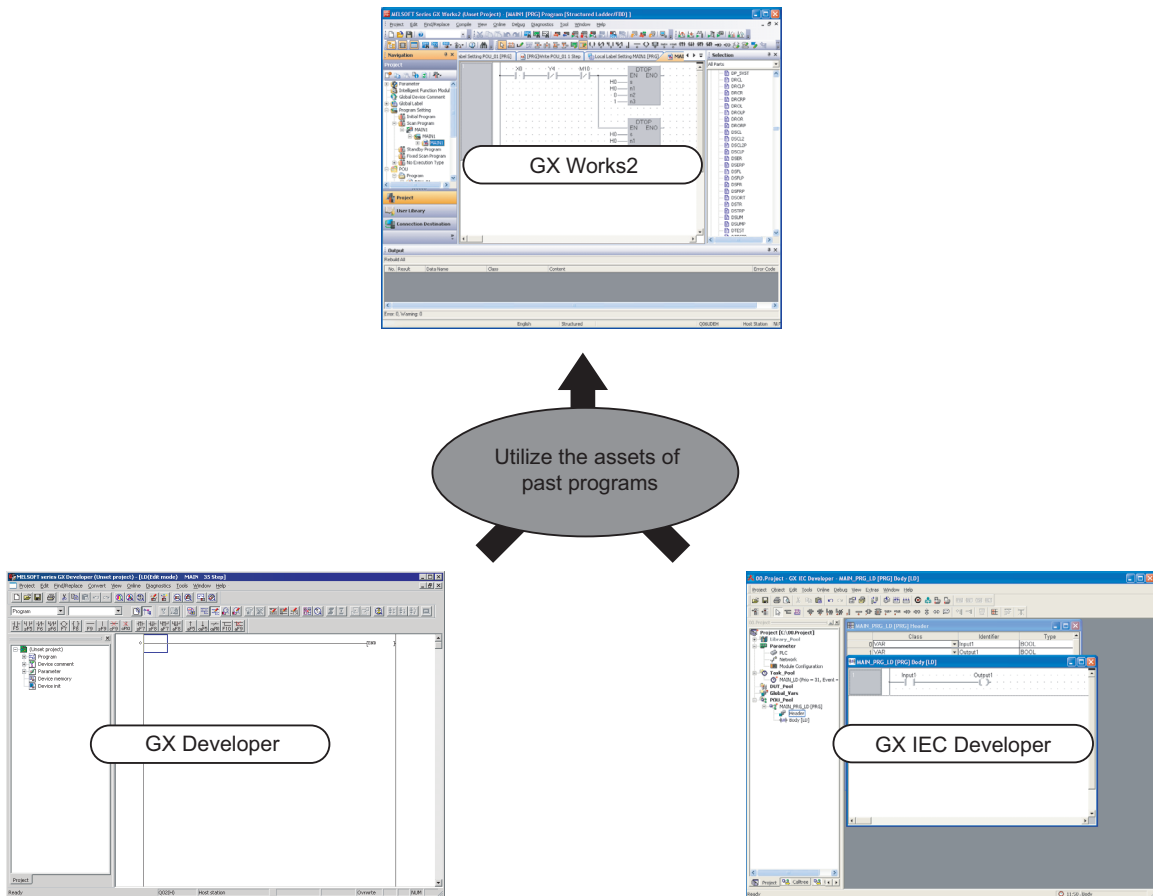

## 1.3 List of Functions

This section shows the list of functions to create programs using Structured Ladder/FBD and Structured Text.

For all the functions of GX Works2 and the functions with "(Common)" indicated in the reference column, refer to the following manual.

(Common) ... GX Works2 Version 1 Operating Manual (Common)

### 1.3.1 List of functions common to Simple project and Structured project

This section explains the functions common to Simple project and Structured project.

#### ■ List of common functions

The following tables show functions that are available regardless of the type of editing or setting target.

Project (common function)		Reference
Object		-
New	Add data to the project.	(Common)
Rename	Rename the selected data.	
Delete	Delete the selected data.	
Copy	Copy the selected data.	
Paste	Paste the copied data.	
Set as Default Connection	Specify data in selected connection destination as a connection destination for regular use.	
Property	Display the selected data properties.	
Library		-
Create	Create a new library.	Section 13.2.1
Install	Import a created library to the project.	Section 13.3.1
Deinstall	Delete the library from the project.	Section 13.2.5
Reload	Update the library imported to the project.	Section 13.3.4
Rename	Rename the library.	Section 13.2.2
Open	Enable editing of the library.	Section 13.3.3
Close	Disable editing of the library.	
Change Password	Set a password for the library.	Section 13.2.6
Save As	Name and save the project.	Section 13.2.4
Save	Save the library file.	
Help	Display help information of the library.	Section 13.3.5

Edit (common function)		Reference
Undo	Restore the previous processing status.	Section 6.2.3
Redo	Restore the processing deleted with [Undo].	
Cut	Cut the selected data.	-
Copy	Copy the selected data.	
Paste	Paste the cut or copied data at the cursor position.	
Compile (common function)		Reference
Build	Convert/compile a program being edited.	Section 10.1
Online Program Change	Write sequence programs to a programmable controller CPU after the conversion/compilation.	(Common)
Rebuild All	Convert/compile all programs in the project.	Section 10.2
View (common function)		Reference
Docking Window		-
Navigation	Display/hide the Navigation window.	(Common)
Element Selection	Display/hide the Element Selection window. Select a part such as function block and function on the window for utilizing it to a program.	Section 6.2.1
Output	Display/hide the Output window. The conversion (compilation) result is displayed.	Section 10.6
Online (common function)		Reference
Read from PLC	Read data from the programmable controller CPU.	Section 11.1
Write to PLC	Write data to the programmable controller CPU.	
Monitor		-
Start Monitoring (All Windows)	Start monitoring the programs of all open windows.	(Common)
Stop Monitoring (All Windows)	Stop monitoring the programs of all open windows.	
Start Monitoring	Start monitoring the program of the open window.	Section 12.1.1
Stop Monitoring	Stop monitoring the program of the open window.	Section 12.1.2
Change Value Format (Decimal)	Display the current device value in decimal in program monitoring.	Section 12.3.1
Change Value Format (Hexadecimal)	Display the current device value in hexadecimal in program monitoring.	
Change Instance (Function Block)	Select an instance of the function block to be monitored.	Section 12.2
Tool (common function)		Reference
Check Device Duplication of Global Label	Check duplications of devices assigned to global labels, and display the result.	Section 5.7
Device/Label Automatic-Assign Setting	Set device range to be automatically assigned to a label.	Section 5.8
Options	Set various options.	Chapter 14

## ■ List of functions for setting labels

The following table shows the functions for setting and editing labels.

Edit (function for label setting)		Reference
Delete	Delete the selected data.	-
Select All	Select all items.	Section 5.5.5
New Declaration (Before)	Add a row above the cursor position.	
New Declaration (After)	Add a row below the cursor position.	
Delete Row	Delete the row at the cursor position.	Section 5.9
Read from CSV File	Read label settings from the CSV file.	
Write to CSV File	Write label settings to the CSV file.	
System Label		-
Reservation to Register System Label	Reserve the selected global label for registration as a system label.	Section 5.2
Reservation to Release System Label	Reserve the selected global label for deregistration of system label.	
Import System Label	Import system label information and apply it to global labels.	
Reflect to System Label Database	Apply the registration-reserved/deregistration-reserved global labels to the system label data base.	-
Confirm Update of System Label Database	Apply system label information changed in another project to global labels.	
Execute Verification Synchronous with System Label	Resolve a mismatch when system label information contains it.	
Sort		-
Class	Sort the labels in ascending/descending order with the selected item.	Section 5.5.5
Label Name		
Data Type		
Constant		
Device		
Address		
Comment		
Remark		
Unused label list	Extract and display unused labels. Extracted unused labels can be deleted in batch.	Section 5.5.6

1

OVERVIEW

2

SCREEN CONFIGURATION

3

PROGRAMMING PROCEDURE

4

PROGRAM CONFIGURATIONS

5

SETTING LABELS

6

COMMON OPERATIONS OF PROGRAM EDITORS

7

EDITING STRUCTURED PROGRAMS

8

EDITING STRUCTURED LADDER/FBD PROGRAMS

### 1.3.2 List of functions for editing in Structured Text

The following tables show the functions for editing with the ST editor.

Edit (function for editing in Structured Text)		Reference
Delete	Delete the selected data.	-
List Operands	Display the screen for inserting a label by selecting an existing label.	Section 6.2.2
Display Template	Insert a template corresponds to the instruction, function, or control syntax.	Section 7.1.4
Mark Template (Left)	Set an argument of the template in the selected status from the left by selecting the menu each time.	
Mark Template (Right)	Set an argument of the template in the selected status from the right by selecting the menu each time.	

Find/Replace (function for editing in Structured Text)		Reference
Jump	Jump to the specified line.	Section 9.1.1
Bookmark		-
Toggle Bookmark	Set a bookmark at the cursor line. The bookmark is deleted when one is already set at the cursor line.	Section 9.1.2
Bookmark List	Jump to the specified bookmark from the bookmark list.	
Next Bookmark	Display the next bookmark position.	
Previous Bookmark	Display the previous bookmark position.	
Delete All Bookmarks	Cancel all bookmarks.	

View (function for editing in Structured Text)		Reference
Display Compile Result	Display the compilation result in a list format.	Section 6.2.7
Zoom		-
Set Zoom Factor	Change the display size of the program.	Section 6.2.4
Increase Zoom		
Decrease Zoom		
Zoom Header/Body		-
Header	Open the label setting editor in the selected POU.	Section 6.2.9
Body	Open the program editor in the selected POU.	
Open Header	Open the <u>Local Label Setting</u> screen for the program being edited.	Section 6.2.6

Online (function for editing in Structured Text)		Reference
Monitor		-
Start Monitoring	Start monitoring with the split window format that displays monitor data of numeric value and character strings.	Section 12.4
Start Monitor (bit type only)	Start monitoring only bit type devices/labels.	



### 1.3.3 List of functions for editing in Structured Ladder/FBD

The following tables show the functions for editing with the Structured Ladder/FBD editor.

Edit (function for editing in Structured Ladder/FBD)		Reference
Delete	Delete the selected data.	-
Select Mode	Change to the contact and coil input mode.	Section 8.4.1
Interconnect Mode	Change to the line drawing mode.	Section 8.3.2
Auto Connect	Specify and connect the start and end points to draw a line.	Section 8.3.3
Guided Mode		-
Guided Editing	Change to the keyboard input mode.	Section 8.10
Overwrite Mode	Overwrite the element entered in Guided editing at the cursor position.	Section 8.10.1
Insert Mode	Insert the element entered in Guided editing at the cursor position.	
Line Mode	Change the input format to draw lines in Guided editing.	Section 8.10.4
Auto Comment	Add a comment entry field at the start of the ladder block added in Guided editing.	Section 8.10.9
Recalculate Line	Arrange a line automatically to redraw it.	Section 8.3.5
Insert Row	Insert a row in a ladder program being edited.	Section 8.3.6
Insert Column	Insert a column in a ladder program being edited.	
New Ladder Block List		-
Top	Insert a new ladder block at the start of all ladder blocks.	Section 8.8.1
Before	Insert a new ladder block in front of a ladder block being edited.	
After	Insert a new ladder block after a ladder block being edited.	
Bottom	Insert a new ladder block at the end of all ladder blocks.	
Input Instruction	Open the <u>Input Instruction</u> screen.	Section 8.2.2

1  
OVERVIEW

2

SCREEN  
CONFIGURATION

3

PROGRAMMING  
PROCEDURE

4

PROGRAM  
CONFIGURATIONS

5

SETTING LABELS

6















COMMON  
OPERATIONS OF  
PROGRAM EDITORS

7

EDITING ST  
PROGRAMS

8

EDITING STRUCTURED  
LADDER/FBD  
PROGRAMS

Edit (function for editing in Structured Ladder/FBD)		Reference
Ladder Symbol		-
Open Contact	Insert  at the cursor position.	Section 8.2.1
Close Contact	Insert  at the cursor position.	
Coil	Insert  at the cursor position.	
Jump	Insert  at the cursor position.	
Return	Insert  at the cursor position.	
Open Branch	Insert  at the cursor position.	
Close Branch	Insert  at the cursor position.	
Input Label	Insert  at the cursor position.	
Output Label	Insert  at the cursor position.	
Horizontal Line Segment	Insert  at the cursor position.	
Vertical Line Segment	Insert  at the cursor position.	
Rising Pulse	Insert  at the cursor position.	
Falling Pulse	Insert  at the cursor position.	
Rising Pulse Close	Insert  at the cursor position.	
Falling Pulse Close	Insert  at the cursor position.	
Comment	Insert a comment entry field at the cursor position.	
Ladder Block Label	Display the <u>Ladder Block</u> screen.	Section 8.8.4
Left Power Rail	Display/hide the left power rail.	Section 8.8.7
List Operands	Display the screen for inserting a label by selecting an existing label.	Section 6.2.2
Number of Pins		-
Increment	Increase the number of arguments of functions and function blocks.	Section 8.6.3
Delete	Decrease the number of arguments of functions and function blocks.	
Ladder Block List	Display a list of ladder blocks in a program.	Section 8.8.5
Signal Configuration		-
Configure	Set the type of a contact and a coil.	Section 8.5
Toggle	Change the contact and coil type per execution in the following order. <ul style="list-style-type: none"> <li>• Contact: Open Contact → Close Contact</li> <li>• Coil: Normal → Negation → Set → Reset</li> </ul>	
Find/Replace (function for editing in Structured Ladder/FBD)		Reference
Jump	Jump to the specified ladder block number.	Section 9.2.1

View (function for editing in Structured Ladder/FBD)		Reference
View Mode		-
Label	Display variables by its entered format.	Section 8.7.4
Device	Display devices/addresses in device format. Devices assigned to labels are displayed in device format.	
Address	Display devices/addresses in address format. Devices assigned to labels are displayed in address format.	
Comment	Display devices/addresses in device comment. Labels are displayed in label comment.	
Change Label-Device-Address Mode	Switch the display format in order (label, device, address).	
Change Label-Comment Mode	Switch the display between label and comment.	
Add Label Display Items		Section 8.7.4
Device	Display devices assigned to labels.	
Address	Display addresses assigned to labels.	
Label Comment	Display label comments assigned to labels.	
Device Comment	Display device comments correspond to devices or addresses.	
All Device Display	Batch-change all labels on the program editors to the device display.	
Cancel All Device Display	Cancel the device display on the program editors, and display data in the format at the time of data entry.	
Grid	Show a grid on the screen being edited to display the start/end positions of a line.	Section 8.8.8
Print Wrap Position	Display the wrapping position for printing.	Section 8.11
Display Compile Result	Display the compilation result in a list format.	Section 6.2.7
Zoom		-
Set Zoom Factor	Change the display size of the program.	Section 6.2.4
Increase Zoom		
Decrease Zoom		
Zoom Header/Body		-
Header	Open the label setting editor in the selected POU.	Section 6.2.9
Body	Open the program editor in the selected POU.	
Open Header	Open the <u>Local Label Setting</u> screen for the program being edited.	Section 6.2.6

1  
OVERVIEW2  
SCREEN CONFIGURATION3  
PROGRAMMING PROCEDURE4  
PROGRAM CONFIGURATIONS5  
SETTING LABELS6  
COMMON OPERATIONS OF PROGRAM EDITORS7  
EDITING ST PROGRAMS8  
EDITING STRUCTURED LADDER/FBD PROGRAMS





# 2

# SCREEN CONFIGURATION

This chapter explains the screen configuration of GX Works2.

2.1	Overview of Screen Configuration
-----	----------------------------------

2 - 2

1	OVERVIEW
2	SCREEN CONFIGURATION
3	PROGRAMMING PROCEDURE
4	PROGRAM CONFIGURATIONS
5	SETTING LABELS
6	COMMON OPERATIONS OF PROGRAM EDITORS
7	EDITING ST PROGRAMS
8	EDITING STRUCTURED LADDER/FBD PROGRAMS

# 2.1 Overview of Screen Configuration

Q CPU L CPU FX

This section explains the main frame (basic screen) of GX Works2 that is displayed when it is started up.

The following screen shows a main frame configuration on which a work window and docked windows are displayed.

## Screen display

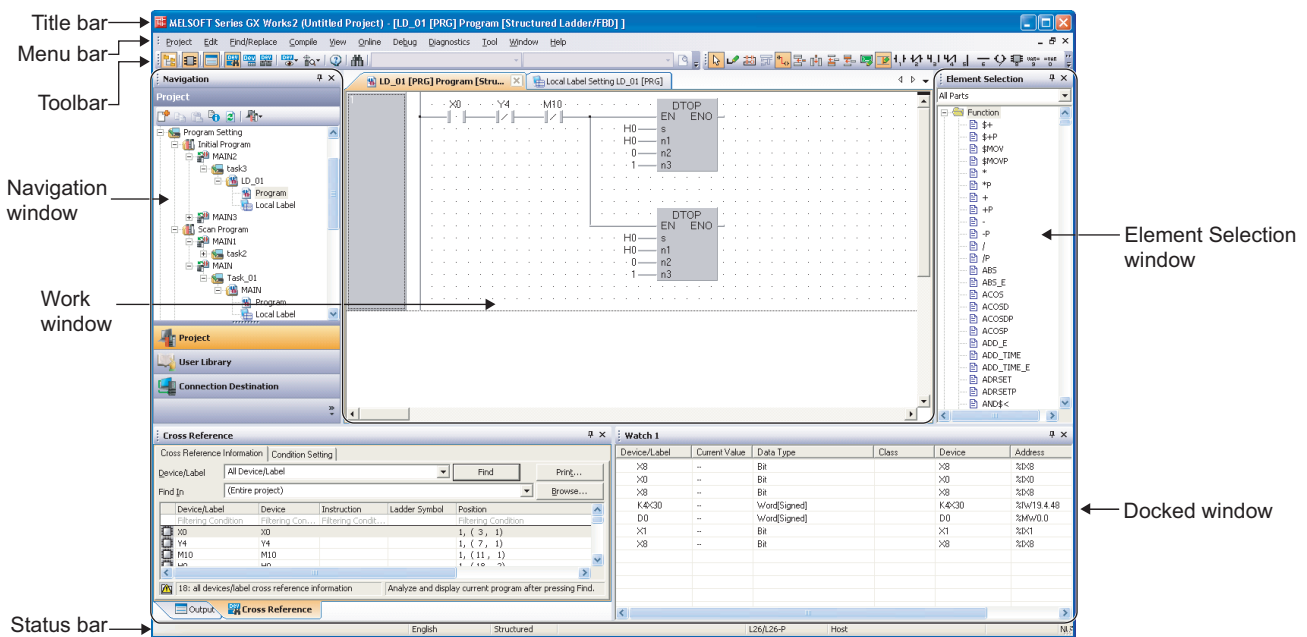

## Display contents

Name	Description	Reference
Title bar	Display a project name.	-
Menu bar	Display menu options for executing each function.	-
Toolbar	Display tool buttons for executing each function.	Appendix 1
Work window	A main screen used for operations such as programming, parameter setting, and monitoring.	GX Works2 Version 1 Operating Manual (Common)
Docking window	A sub screen to support operations performed on a work window.	
Navigation	Display contents of a project in tree format.	Section 4.1
Element Selection	Display a list of functions (such as function blocks) used for programming.	Section 6.2.1
Output	Display compilation and check results (errors and warnings).	Section 10.6
Cross Reference	Display cross reference results.	GX Works2 Version 1 Operating Manual (Common)
Device List	Display the device usage list.	
Device Reference	Display assignments of refresh devices and link devices specified for the CC-Link parameter.	GX Works2 Version 1 Operating Manual (Intelligent Function Module)
	Display assignments of refresh devices and input/output devices specified for the AnyWireASLINK parameter.	
Watch 1 to 4	A screen used for monitoring and changing current device values.	GX Works2 Version 1 Operating Manual (Common)
Intelligent Function Module Monitor 1 to 10	A screen used for monitoring intelligent function modules.	
Find/Replace	A screen used for searching and replacing character strings in the project.	
Debug	A screen used for setting the debug which uses the simulation function.	
Status bar	Display information about a project being edited.	

1	OVERVIEW
2	SCREEN CONFIGURATION
3	PROGRAMMING PROCEDURE
4	PROGRAM CONFIGURATIONS
5	SETTING LABELS
6	COMMON OPERATIONS OF PROGRAM EDITORS
7	EDITING ST PROGRAMS
8	EDITING STRUCTURED LADDER/FBD PROGRAMS

# MEMO

---

---

---

---

---

---

---

---

---

---

---

---

---

---

---

---

---

---

---

---

---

---

---

---

---

---





# 3 PROGRAMMING PROCEDURE

This chapter explains how to create programs in Structured project.

3.1 Creating Programs

3 - 2

1	OVERVIEW
2	SCREEN CONFIGURATION
<b>3</b>	<b>PROGRAMMING PROCEDURE</b>
4	PROGRAM CONFIGURATIONS
5	SETTING LABELS
6	COMMON OPERATIONS OF PROGRAM EDITORS
7	EDITING ST PROGRAMS
8	EDITING STRUCTURED LADDER/FBD PROGRAMS

## 3.1 Creating Programs

Q CPU L CPU FX

This section explains the general operating steps from the creation of a program in Structured project to the execution of the created program on the programmable controller CPU.

### Operating procedure

#### 1. Creating a new project

Procedure	Reference
Start up GX Works2.	GX Works2 Version 1 Operating Manual (Common)
Create a new Structured project. To reuse an existing Structured project, open that Structured project.	



#### 2. Setting parameters

Procedure	Reference
Set parameters.	GX Works2 Version 1 Operating Manual (Common)
Check parameters.	



#### 3. Configuring programs

Procedure	Reference
Create program files.	Chapter 4
Create tasks.	
Create POUs.	
Register POUs (program blocks) to the tasks.	



#### 4. Setting labels

Procedure	Reference
Define global labels.	Chapter 5
Define local labels.	



(To the next page)

(From the previous page)



## 5. Editing programs

Procedure	Reference
Edit programs of each POU.	Chapter 6 Chapter 7 Chapter 8



## 6. Compiling programs

Procedure	Reference
Compile a program or compile all programs.	Chapter 10



## 7. Connecting a personal computer to the programmable controller CPU

Procedure	Reference
Connect a personal computer to the programmable controller CPU.	GX Works2 Version 1 Operating Manual (Common)
Set the connection destination.	



## 8. Writing data to the programmable controller CPU

Procedure	Reference
Write parameters to the programmable controller CPU.	Chapter 11
Write sequence programs to the programmable controller CPU.	



## 9. Confirming the operation

Procedure	Reference
Monitor the execution status of sequence programs.	Chapter 12



## 10. Ending the project

Procedure	Reference
Save the project.	GX Works2 Version 1 Operating Manual (Common)
Exit GX Works2.	

1  
OVERVIEW2  
SCREEN  
CONFIGURATION3  
PROGRAMMING  
PROCEDURE4  
PROGRAM  
CONFIGURATIONS5  
SETTING LABELS6  
COMMON  
OPERATIONS OF  
PROGRAM EDITORS7  
EDITING ST  
PROGRAMS8  
EDITING STRUCTURED  
LADDER/FBD  
PROGRAMS





# 4 PROGRAM CONFIGURATIONS

In Structured project, sequence programs are configured by using tasks and POUs. This chapter explains the program configurations of Structured project.

4.1	Program Configurations of Structured Project	4 - 2
4.2	Creating Program Files and Tasks	4 - 3
4.3	Creating POUs	4 - 10
4.4	Using POUs	4 - 14

# 4.1 Program Configurations of Structured Project

**Q CPU** **L CPU** **FX**

This section explains the configurations of Structured project that are displayed in a tree format on the Project view.

Display contents differ depending on the programmable controller type. The following shows an example of QCPU (Q mode).

For (Common) and (Intelligent) indicated as the reference, refer to the following manuals respectively:

- (Common) ... GX Works2 Version 1 Operating Manual (Common)
- (Intelligent) ... GX Works2 Version 1 Operating Manual (Intelligent Function Module)

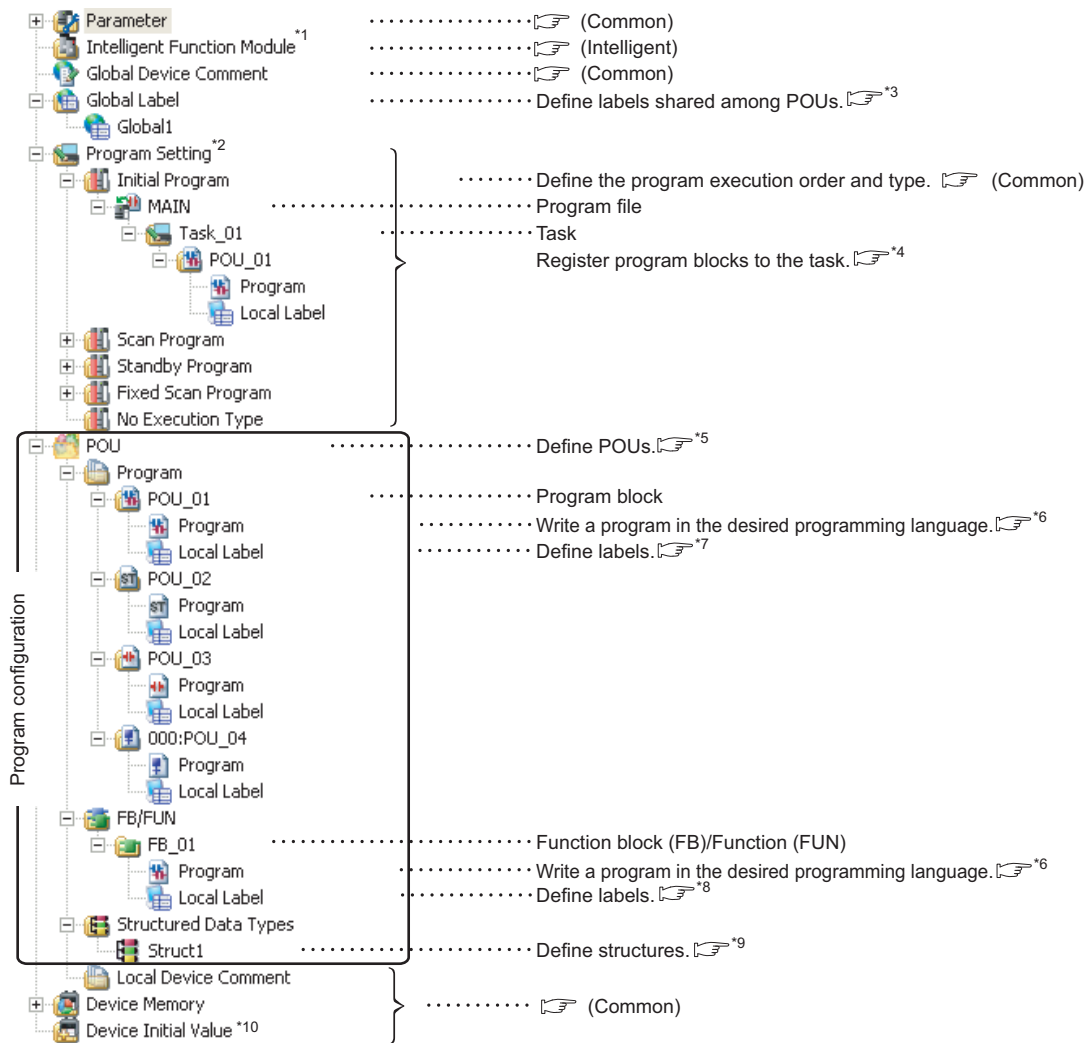

\*1 : For FXCPU, "Special Module (Intelligent Function Module)" is displayed.  
 \*2 : For FXCPU, no classification for program execution type. Only one item, "Execution Program", is displayed.  
 \*3 : Section 5.2  
 \*4 : Section 4.2  
 \*5 : Section 4.3  
 \*6 : Chapter 6, Chapter 7, Chapter 8  
 \*7 : Section 5.3  
 \*8 : Section 5.4  
 \*9 : Section 5.6  
 \*10 : For FXCPU, this item is not displayed.

## 4.2 Creating Program Files and Tasks

Q CPU L CPU FX

This section explains how to register program blocks executed on the programmable controller CPU, and setting the executing conditions of programs using program files and tasks.

For details of program files and tasks, refer to the following manual.

👉 MELSEC-Q/L/F Structured Programming Manual (Fundamentals)

### 4.2.1 Procedure for creating program files and tasks

The following explains the procedure for creating a program file and task.

#### Operating procedure

##### 1. Creating a program file and task

Procedure	Reference
Create a program file. Select Project view ⇒ "Program Setting" ⇒ "(program setting)", and perform the following operation. <ul style="list-style-type: none"> <li>• Select [Project] ⇒ [Object] ⇒ [New].</li> </ul>	GX Works2 Version 1 Operating Manual (Common)
Create a task. Select Project view ⇒ "Program Setting" ⇒ "(program setting)" ⇒ "(program file)", and perform the following operation. <ul style="list-style-type: none"> <li>• Select [Project] ⇒ [Object] ⇒ [New].</li> </ul>	



##### 2. Registering program blocks to the task

Procedure	Reference
Display the <u>Task Setting</u> screen. Select Project view ⇒ "Program Setting" ⇒ "(program setting)" ⇒ "(program file)" ⇒ "(task)".	GX Works2 Version 1 Operating Manual (Common)
Set program blocks to be registered to the task.	Section 4.2.2



##### 3. Setting the executing condition

Procedure	Reference
Set the executing condition (execution type) of the program file.	Section 4.2.3
Set the executing condition on the <u>Property</u> screen of the task. Select the task and perform the following operation. <ul style="list-style-type: none"> <li>• Select [Project] ⇒ [Object] ⇒ [Property].</li> </ul>	

1 OVERVIEW

2 SCREEN CONFIGURATION

3 PROGRAMMING PROCEDURE

4 PROGRAM CONFIGURATIONS

5 SETTING LABELS

6 COMMON OPERATIONS OF PROGRAM EDITORS

7 EDITING ST PROGRAMS

8 EDITING STRUCTURED LADDER/FBD PROGRAMS

## 4.2.2 Registering program blocks to tasks

Register program blocks to a task and specify the executing order. Only the program blocks that are registered to the task are compiled. (☞ Chapter 10)

### Operating procedure

1. Select Project view ⇒ "Program Setting" ⇒ "(program setting)" ⇒ "(program file)" ⇒ "(task)".
2. Right-click and select [Open Task Setting] from the shortcut menu.  
The Task Setting screen is displayed.

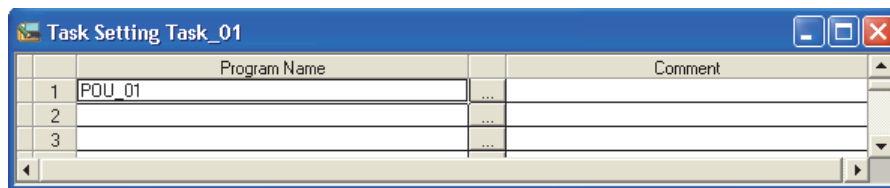

3. Set the items on the screen.

Item	Description	Maximum number of characters
Program Name	Enter a program block name. Click <input type="text"/> to set a program block name on the <u>Program Selection</u> screen.	32
Comment	Enter comments for the program block. A new line can be inserted into a cell by pressing the <input type="text"/> + <input type="text"/> keys.	1024

### Point

- **Program blocks that can be registered**

A single program block can be registered to any one of tasks for only once. Only the program blocks that are not registered to any of the tasks are displayed on the Program Selection screen.

- **Executing order of program blocks registered to a task**

Structured Ladder/FBD or ST programs are executed in the order they are registered to a task.

SFC program is executed in the order of block number, regardless of the order they are registered to the task.



## ■ Registering tasks

A maximum number of tasks that can be created in a single project is 124. A maximum number of program blocks that can be registered to tasks is 800.

However, the number of tasks that can be registered to a program file, the number of program blocks that can be registered to a task, and the type of program block that can be registered to a single task differ according to the selected programming language.

- **Maximum number of tasks that can be created in a single program file and the maximum number of program blocks that can be registered to a single task**

Programming language of program block registered to the first task	Maximum number of tasks that can be created in a single program file	Maximum number of program blocks that can be registered to a single task
Ladder Diagram	1	1
Sequential Function Chart		320*1
Structured Text	124	320
Structured Ladder/FBD		

\*1 : For Basic model QCPU/Q00UJ/Q00U/Q01U/Q02U/L02, the maximum number of SFC blocks is 128.

- **Program block that can be registered to a single task**

○: Applicable, ×: Not applicable

Programming language	Program block that can be registered to a single task			
	Ladder	SFC	ST	Structured Ladder/FBD
Ladder Diagram	○	×	×	×
Sequential Function Chart	×	○	×	×
Structured Text	×	×	○	○
Structured Ladder/FBD	×	×	○	○

1

OVERVIEW

2

SCREEN CONFIGURATION

3

PROGRAMMING PROCEDURE

4

PROGRAM CONFIGURATIONS

5

SETTING LABELS

6

COMMON OPERATIONS OF PROGRAM EDITORS

7

EDITING ST PROGRAMS

8

EDITING STRUCTURED LADDER/FBD PROGRAMS

## ■ Setting program names on the program selection screen

Set a program block on the Task Setting screen using the Program Selection screen.

### Screen display

On the Task Setting screen, click  next to the "Program Name" entry field.

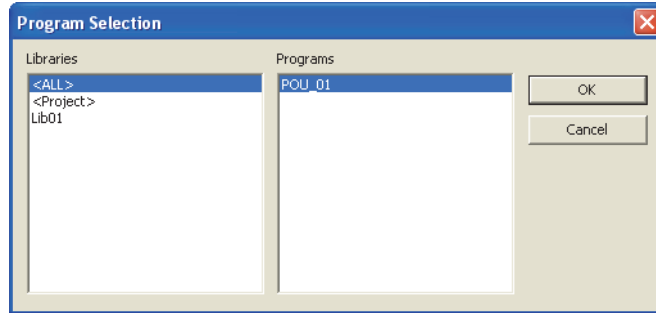

### Operating procedure

1. Select the reference source of the program block from the "Libraries" field.

Libraries	Description
<ALL>	Browse all program blocks defined in the project and libraries.
<Project>	Browse program blocks defined in the project.
(Library name)	Browse program blocks defined in the specified library.

2. Select a program block from the "Programs" field.
3. Click the  button when the setting is completed.

The selected program block is displayed on the Task Setting screen.

### 4.2.3 Setting executing conditions

Set executing conditions for program files and tasks.

#### ■ Executing conditions for program files (execution type)

Executing conditions for program files are set on the <<Program>> tab of PLC parameter. Executing conditions can also be set by dragging and dropping program files on the Project view. For details, refer to the following manual.

☞ GX Works2 Version 1 Operating Manual (Common)

This function is not supported by FXCPU.

#### Screen display

Select Project view ⇒ "Parameter" ⇒ "PLC Parameter" ⇒ <<Program>>.

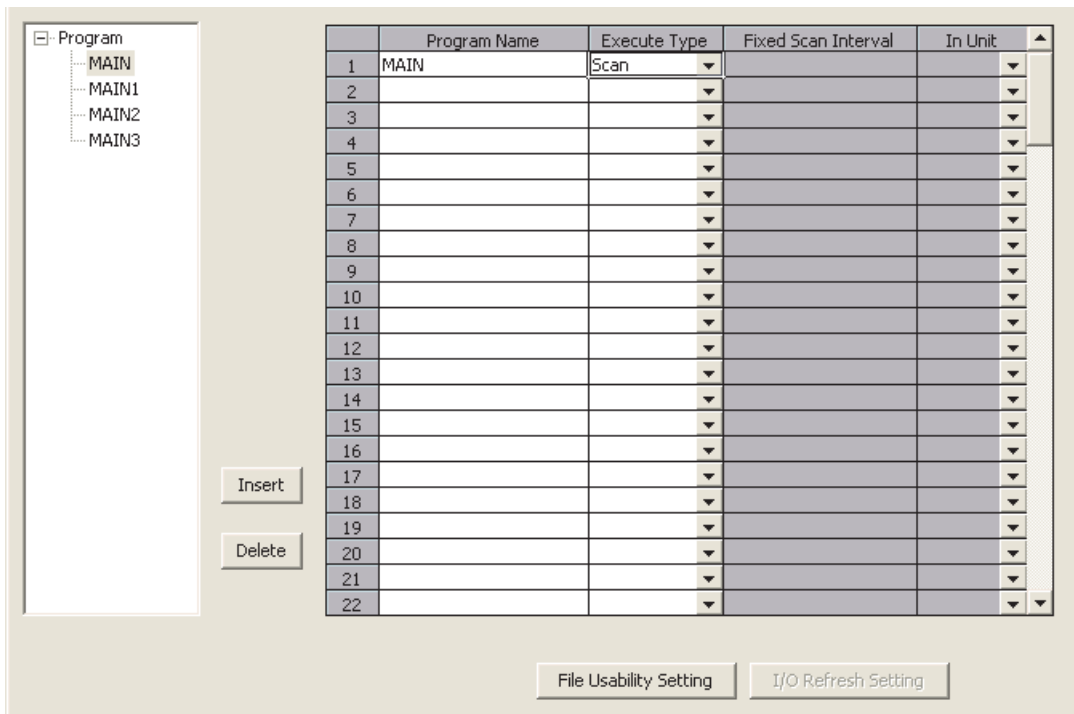

For details of the program executing conditions, refer to the following manual.

☞ User's Manual (Function Explanation, Program Fundamentals) of the CPU module to be used

## ■ Task executing condition

An executing condition for a program file can be set to a task.  
A task executing condition is set on the Property screen of the task.  
Select the task to be set on the Project view in advance.

### Screen display

Select [Project] ⇒ [Object] ⇒ [Property].

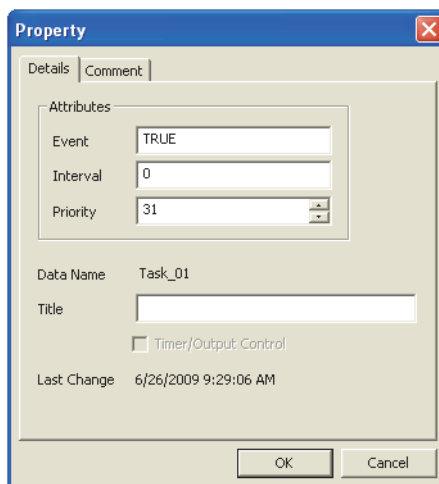

### Operating procedure

- Set the items on the screen.

Item		Description	Task executing condition	
Attributes	Event	TRUE	Execute the task in every scan.	Always
		FALSE	Execute the task in the cycle specified in the "Interval" field.	Interval
		Device or label name	Execute the task when the specified device or label is TRUE.	Event
Attributes	Interval	Set the cycle time to execute the task in a constant cycle. (Enter FALSE in the "Event" field.) Set the cycle time in time type format (Ex.: T#100ms, T#24d20h31m23s647ms). For details of time type format, refer to the following manual. 📖 MELSEC-Q/L/F Structured Programming Manual (Fundamentals) Do not set shorter time than the scan time of sequence program.		
		Priority	Set the task execution priority in the range from 0 to 31. Tasks with smaller values are executed by priority. Tasks of the same priority are executed in the alphabetical order of task data names.	
Title		Enter a title of the task.		
Timer/Output Control	Selected	The outputs and the current values of timers in the task are reset when the task is not executed.		
	Cleared	The outputs and the current values of timers in the task are retained when the task is not executed.		

**Point**

● **Interruption start for QCPU (Q mode)/LCPU**

To enable an interruption start, set an interrupt pointer number (I0 to I31) in the "Event" field. In this case, create a program using the basic instruction EI (Enable Interrupt) for the program blocks registered to scan execution tasks.

● **Interruption start for FXCPU**

The following shows the settings for FXCPU.

- I□01 (rising input interruption), I□00 (falling interruption)
- I6□□ to I8□□ (timer interruption)
- I010 to I060 (counter interruption)

For details, refer to the following manual.

 FXCPU Structured Programming Manual [Device & Common]

● **When the program block registered to the task is created in Ladder Diagram**

When the program block registered to the task is created in Ladder Diagram, items of "Attributes" cannot be set.

● **When the program end instruction is used**

When the program end instruction, such as the FEND instruction and GOEND instruction, is used, program blocks and/or tasks following the program end instruction are not executed.

The following tables show the task executing order according to the set execution type (always (priority: high/low), interval, or event) in the task property setting.

Task name	Task attributes			Task executing condition
	Event	Interval	Priority	
Task 1	TRUE	0	31	Always (priority: low)
Task 2	M0	0	31	Event
Task 3	FALSE	T#100ms	31	Interval
Task 4	TRUE	0	30	Always (priority: high)



Executing order	Task name	Execution timing
1	Task 4	Executed in every scan
2	Task 1	Executed in every scan
3	Task 2	When M0 turned ON
4	Task 3	In every 100ms

1	OVERVIEW
2	SCREEN CONFIGURATION
3	PROGRAMMING PROCEDURE
4	PROGRAM CONFIGURATIONS
5	SETTING LABELS
6	COMMON OPERATIONS OF PROGRAM EDITORS
7	EDITING ST PROGRAMS
8	EDITING STRUCTURED LADDER/FBD PROGRAMS

## 4.3 Creating POU's

Q CPU L CPU FX

This section explains how to create POU's.

A POU (abbreviation for Program Organization Unit) is a unit of program defined for each function.

### 4.3.1 Procedure for creating POU's

The following explains the procedure for creating a POU.

#### Operating procedure

#### 1. Creating a new POU

Procedure	Reference
Create a POU. • Select [Project] ⇒ [Object] ⇒ [New].	GX Works2 Version 1 Operating Manual (Common)



#### 2. Setting local labels

Procedure	Reference
Display the <u>Local Label Setting</u> screen or <u>Function/FB Label Setting</u> screen. • Select Project view ⇒ "POU" ⇒ "Program" ⇒ "(POU)" ⇒ "Local Label".	Chapter 5
Set labels that are used only within the POU.	



#### 3. Editing the program

Procedure	Reference
Display the program editor. • Select Project view ⇒ "POU" ⇒ "Program" ⇒ "(POU)" ⇒ "Program".	Chapter 6
Edit the program in the specified programming language.	

## 4.3.2 Setting properties of functions and function blocks

Set properties of a function and function block.

Select a function or function block to be set on the Project view in advance.

### Screen display

Select [Project] ⇒ [Object] ⇒ [Property].

<For function>

<For function block>

### Operating procedure

- Set the items on the screen.

Item		Description
Result Type		Set the data type of return value of the function. Click <input type="button" value="..."/> and select a data type from the list.
Use Macrocode*1, *2	Selected	Apply function block program codes to each location where instances are used at compilation. Even if EN of the function block is OFF, the output variable is retained at ON. To turn OFF the output variable when EN is OFF, select the "Use MC/MCR" check box below.
	Cleared	Create function block program codes for each function block at compilation. Codes are created to call function blocks for each location where instances are used. To call function blocks, use automatically assigned devices. Section 5.8
Use MC/MCR*1, *2, *3	Selected	Apply function block program codes using the MC/MCR instruction to each location where instances are used at compilation.
	Cleared	Apply function block program codes using the CJ instruction to each location where instances are used at compilation.
Use EN/ENO*1, *2	Selected	Become a function or function block with EN/ENO.
	Cleared	Become a function or function block without EN/ENO.

\*1 : This item cannot be selected when using ladder function blocks.

\*2 : This item cannot be selected when using ST function blocks in Simple project.

\*3 : This item can be selected only when the check boxes of both "Use Macrocode" and "Use EN/ENO" are selected.

**Point**

● "Use MC/MCR"

- This check box can be selected only if both "Use EN/ENO" and "Use Macrocode" are selected.
- If the MC/MCR instruction is used and the function block is not executed, the outputs and the current values of timers in the function block are reset. (If the instruction is not used, the current values are retained).

● Return value of function

Program the function names as labels in a function to set a return value.  
 Setting function names as labels is not necessary. Data type set on "Result Type" can be used.

Example: Set return value of function name "FUN\_01" to 0

<Structured Ladder/FBD>

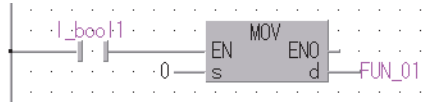

<ST>  
 FUN\_01 := 0;

● Applying function blocks to locations where instances are used

The following shows the example of codes when the following programs are compiled.  
 Note that devices are assigned as follows:

- Input1 : X0
- Input2 : X11
- Output1 : D10

<The program at the location of use>

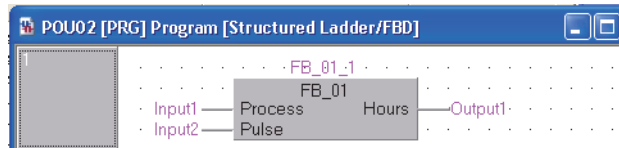

<Function block>

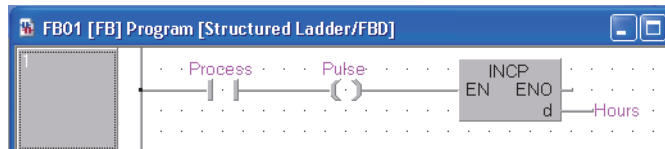

Use Macrocode	Code to be created in the program at the location of use	Function block code
Applied (The check box is selected.)	LD X0 AND X11 INCP D10	None
Not applied (The check box is cleared.)	LD X0 OUT M4096 LD X11 OUT M4097 LD SM400 CALL P2048 LD SM400 MOV D6144 D10	P2048 LD M4096 AND M4097 INCP D6144 RET

When "Add temporary variables as arguments to use macrocode" under [Tool] ⇒ [Options] ⇒ "Compile" ⇒ "Structured Ladder/FBD/ST" ⇒ "Compile Condition1" is selected, clear the check box.



**Point**

● **When "Use Macrocode" is cleared**

Since pointers of automatically assigned devices are used, the number of function instances that can be created is limited to the number of pointers or less specified on the Device/Label Automatic-Assign Setting screen. (Section 5.8)  
 Select "Use Macrocode", if the number of set pointers or more instances are required.

● **Using the MC/MCR instruction for EN control**

The following shows the example of codes when the following programs are compiled. Note that devices are assigned as follows:

- Input1 : X0
- Input2 : X11
- Output1 : D10

<The program at the location of use>

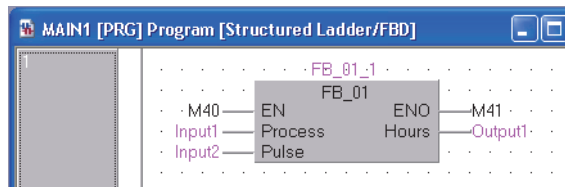

<Function block>

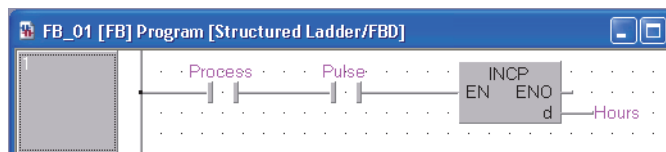

Use MC/MCR	Code to be created in the program at the location of use
MC/MCR is used (The check box is selected.)	LD M40 OUT M41 MC N0 M4096 LD X0 AND X11 INCP D10 MCR N0
MC/MCR is not used (The check box is cleared.)	LD M40 OUT M41 LDI M40 CJ P2050 LD X0 AND X11 INCP D10 P2050

1	OVERVIEW
2	SCREEN CONFIGURATION
3	PROGRAMMING PROCEDURE
4	PROGRAM CONFIGURATIONS
5	SETTING LABELS
6	COMMON OPERATIONS OF PROGRAM EDITORS
7	EDITING ST PROGRAMS
8	EDITING STRUCTURED LADDER/FBD PROGRAMS

## 4.4 Using POU

**Q CPU** **L CPU** **FX**

This section explains how to use the created POU.

- Program blocks are used by registering them to tasks. (☞ Section 4.2.2)
- Functions and function blocks are used in program blocks. (☞ Section 4.4.1)

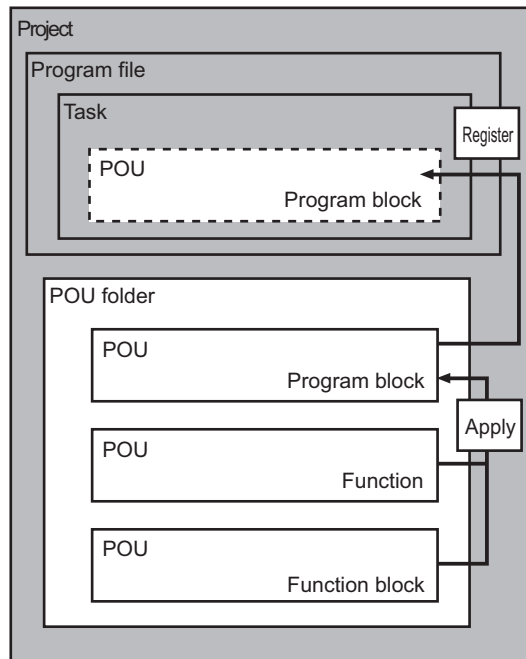

## 4.4.1 Using functions and function blocks

Select a function or function block from the Element Selection window and insert it into a program. (Element Selection window  Section 6.2.1)

### Operating procedure

1. On the Project view, select ⇒ "POU" ⇒ "Program" ⇒ "(program)" ⇒ "Program".  
The program editor is displayed.

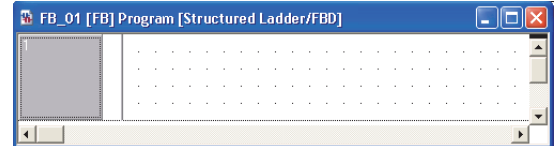

2. Select [View] ⇒ [Docking Window] ⇒ [Element Selection] ().

The Element Selection window is displayed.

3. Select "Project" from the combo box.

The functions and function blocks defined in the project are displayed in tree format.

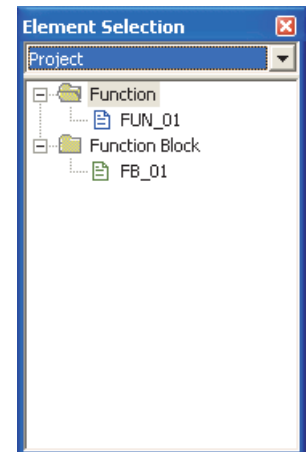

4. Select a function or function block and then drag and drop it to the program editor.

The selected function or function block is inserted into the specified position on the editor.

On the Structured Ladder/FBD editor, the cursor position at the time of the drop operation becomes the position of the input pin at the upper left of the function or function block.

5. Set an instance name.

For a function block, set an instance name on the Label Registration/Selection screen displayed when a function/function block is dropped. For the method for setting the Label Registration/Selection screen, refer to the following section.  Section 6.2.2 "Using labels in the program"

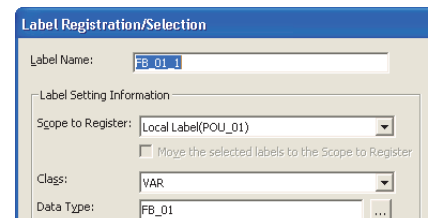

6. Set an argument.

Enter a device or label name for the argument defined in the function or function block.

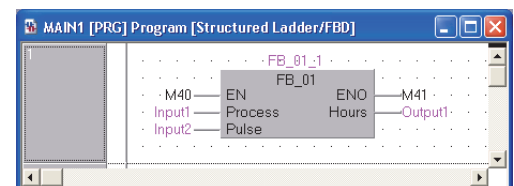

### Point

#### ● Inserting functions and function blocks

Functions and function blocks can be also inserted by the following operation.

- Select a function or a function block from the Project view, and drag and drop it to the desired position.

## Using function blocks created in other programming languages

Use function blocks created in other programming languages.

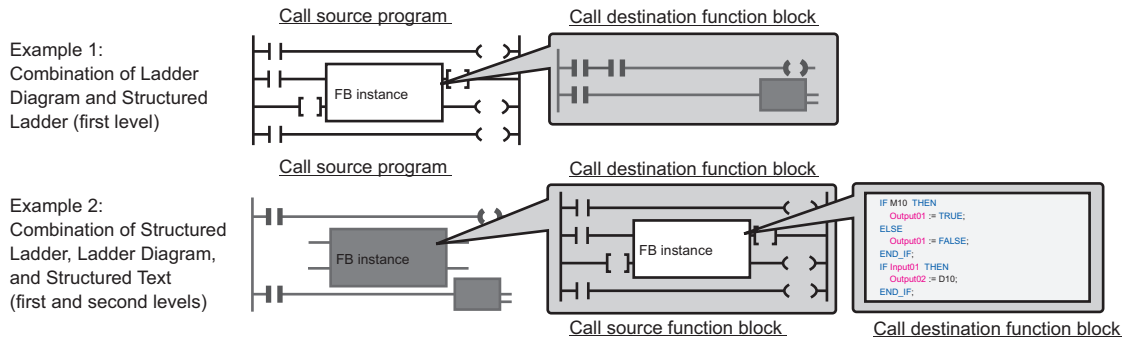

The following table shows the function blocks that can be called from the program/function block.

○:Call function applicable, ×:Call function inapplicable

		Call destination function block		
		Ladder*1	Structured Ladder/FBD	ST
Call source program	Ladder*1	○	○*2	○*2
	Structured Ladder/FBD	○*2	○	○
	ST	○*2	○	○
	SFC (Zoom) (Operation output only)	○	○*2	○*2
Call source function block	Ladder*1	○*2,*3	×	○*2,*4
	Structured Ladder/FBD	○	○	○
	ST	○	○	○

\*1: For FXCPU, Ladder Diagram is not supported by Structured project.

\*2: Function blocks can be called when "Enable calling function block and using inline ST" is selected under [Tool] ⇒ [Options] ⇒ "Compile" ⇒ "Basic Setting".

\*3: Function blocks in Ladder Diagram that can be called are function blocks in the first level.

\*4: Function blocks of ladder program which are calling function blocks of ST program cannot be used in programs other than Ladder Diagram.

### Point

#### ● When using function block call or inline structured text

The setting in "Basic Setting" under [Tool] ⇒ [Options] ⇒ "Compile" is required. The program becomes uncompiled status when the option setting is changed. Compile the program again.

#### ● When using function blocks created in Structured Ladder/FBD or Structured Text in ladder programs

The following conditions must be satisfied.

- The data type of input/output label is any of the following: bit, word [signed], double word [signed], single-precision real, double-precision real, string.
- The number of input/output labels is 24 or less.
- The number of characters of input/output labels is 16 or less.
- "Use Macrocode" is selected on the Property screen of function block.
- "Use EN/ENO" is not selected in the Property screen of function block.

#### ● Application functions

The application functions shown in "Application functions which cannot be called" are not applicable for the function block called from a ladder program.

Modify the program using the application function which can be called as necessary.

-	Application function name
Application functions which can be called	COUNTER_FB_M, F_TRIG(_E), RS(_E), R_TRIG(_E), SR(_E), TIMER_100_FB_M, TIMER_10_FB_M, TIMER_CONTHFB_M, TIMER_CONT_FB_M, TIMER_HIGH_FB_M, TIMER_LOW_FB_M
Application functions which cannot be called	CTD(_E), CTU(_E), CTUD(_E), TOF(_E), TOF_HIGH(_E), TON(_E), TON_HIGH(_E), TP(_E), TP_HIGH(_E)

For details of each application function, refer to the following manual.

 MELSEC-Q/L Structured Programming Manual (Application Functions)

#### ● Number of program steps\*1

When using function blocks, the number of steps of call destination function block is added to the number of steps of call source program.

#### ● Online program change function\*1

Since the call destination function block itself is also the target of the operation when the Online program change is performed after changing the processing of the front and back of FB instance that is used in the call source program/function block, the data size of call destination function block is added to that of the changed processing for the Online program change operation.

\*1 : When using function blocks created in Structured Ladder/FBD or Structured Text in ladder programs, the function blocks on which "Use Macrocode" is selected on the Property screen are the targets.

1

OVERVIEW

2

SCREEN  
CONFIGURATION

3

PROGRAMMING  
PROCEDURE

4

PROGRAM  
CONFIGURATIONS

5

SETTING LABELS

6

COMMON  
OPERATIONS OF  
PROGRAM EDITORS

7

EDITING ST  
PROGRAMS

8

EDITING STRUCTURED  
LADDER/FBD  
PROGRAMS

# MEMO

---

---

---

---

---

---

---

---

---

---

---

---

---

---

---

---

---

---

---

---

---

---

---

---

---



# 5 SETTING LABELS

This chapter explains how to set labels.

5.1	The Type of Label Setting Editor	5 - 2
5.2	Setting Global Labels	5 - 3
5.3	Setting Local Labels for Program Blocks	5 - 8
5.4	Setting Labels for Functions and Function Blocks	5 - 10
5.5	Common Operations for Setting Labels	5 - 12
5.6	Setting Structure Labels	5 - 23
5.7	Checking Duplications of Devices Assigned to Global Labels	5 - 30
5.8	Setting Ranges for Devices Assigned Automatically	5 - 31
5.9	Writing/Reading Data to/from CSV Files	5 - 34

1	OVERVIEW
2	SCREEN CONFIGURATION
3	PROGRAMMING PROCEDURE
4	PROGRAM CONFIGURATIONS
5	SETTING LABELS
6	COMMON OPERATIONS OF PROGRAM EDITORS
7	EDITING ST PROGRAMS
8	EDITING STRUCTURED LADDER/FBD PROGRAMS

# 5.1 The Type of Label Setting Editor

Q CPU L CPU FX

This section shows label setting editors. Labels are set on each screen below according to the type of label.

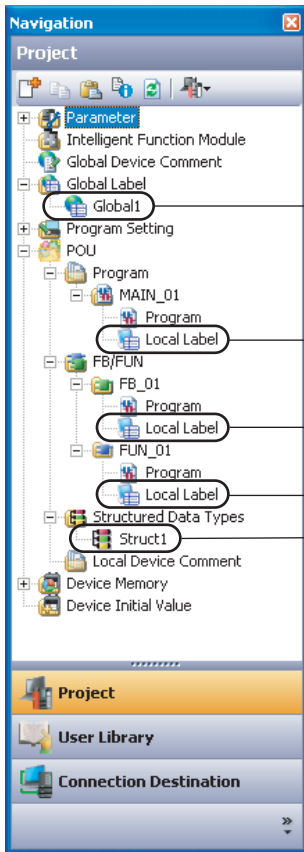

## Global Label Setting screen

Define labels that can be used for all POU in the project. (☞\*1)

Class	Label Name	Data Type	Constant	Device	Address	Comment	Remark	Relation with System Label	System Label Name	Attribute
VAR_GLOBAL	TransportComplete	Bit		M100	M40.100					
VAR_GLOBAL	Emergency_Stop_Switch	Bit		M101	M40.101					
VAR_GLOBAL_CONSTANT	Emergency_Control	Bit	TRUE							
VAR_GLOBAL	Product_A_Data	Struct1		Detail Setting	Detail Setting	Struct1				
VAR_GLOBAL	global_ba1	Bit		DV1	BD16.1			Disclose	global_ba1	Link
VAR_GLOBAL	global_ba2	Bit		J1V1	BD16.1.1			Disclose	global_ba2	Link

System label is reserved to be registered.
  System label is reserved to be released.
  The system label is already registered to the system label database.

To execute the Reservation to Register/Release for the system label, reflection to the system label database is required. Please execute Reflect to System Label Database.

Not Reflected: 0  
 Total: 0

## Local Label Setting screen

Define labels that can be used only for each POU (program block). (☞\*2)

Class	Label Name	Data Type	Constant	Device	Address	Comment
VAR	input1	Bit				
VAR	input2	Bit				
VAR	Output1	Double Word(Signed)				
VAR	FB_01_1	FB_01				
VAR_CONSTANT	data1	String(32)	"ABC"			

## Function/FB Label Setting screen

Define labels that can be used only for each POU (function/function block). (☞\*3)

Class	Label Name	Data Type	Constant	Comment
VAR_INPUT	input1	Bit		
VAR	data1	Time(0..4)		
VAR_CONSTANT	data2	Bit	FALSE	
VAR	data3	Struct1(0..3)		Array of Struct1
VAR_OUTPUT	data4	Bit		

## Structure Setting screen

Define structures to be used for labels. (☞\*4)

Label Name	Data Type	Constant	Member1	Comment
data1	Bit		Member1	
data2	Word(Unsigned)/Bit String(16-bit)		Member2	
data3	Bit(0..2)		Member3	
data4				
data5				

- \*1 : ☞ Section 5.2
- \*2 : ☞ Section 5.3
- \*3 : ☞ Section 5.4
- \*4 : ☞ Section 5.6.1



## 5.2 Setting Global Labels

Q CPU L CPU FX

This section explains how to set global labels.

Global labels can be used in iQ Works supported products (GX Works2, MT Developer2, GT Designer3) by registering them as system labels.

For details of system labels, refer to the following manual.

( iQ Works Beginner's Manual)

### Point

#### ● System labels

Same label names can be used in programming between GX Works2, MT Developer2, and GT Designer3 by using system labels.

#### ● System label data base

A system label data base is a data base to manage system labels.

A system label data base is created in the workspace when the workspace is saved in MELSOFT Navigator.

System labels cannot be used in the workspace which does not contain a system label data base.

### Screen display

Select Project view ⇒ "Global Label" ⇒ "(global label)".

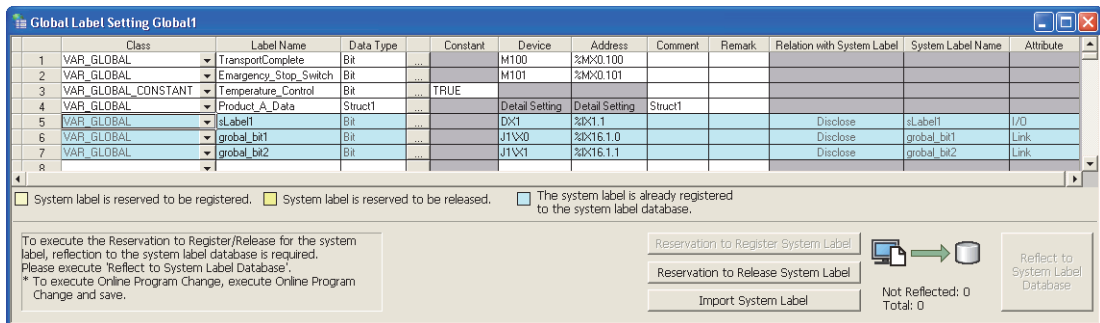

1 OVERVIEW

2 SCREEN CONFIGURATION

3 PROGRAMMING PROCEDURE

4 PROGRAM CONFIGURATIONS

5 SETTING LABELS







6 COMMON OPERATIONS OF PROGRAM EDITORS

7 EDITING ST PROGRAMS

8 EDITING STRUCTURED LADDER/FBD PROGRAMS

## Operating procedure

- Set the items on the screen.

Item	Description	Maximum number of characters								
Class	Select a label class from the list displayed by clicking  . (  Section 5.5.1)	-								
Label Name	Enter a desired label name.	<ul style="list-style-type: none"> <li>• Ladder/SFC: 32 (FB instance name: 16)</li> <li>• Structured Ladder/FBD/ST: 32</li> </ul>								
Data Type	Set a data type from the <u>Data Type Selection</u> screen displayed by clicking  . (  Section 5.5.3) It can also be entered directly.	128								
Constant	Enter a constant value when "VAR_GLOBAL_CONSTANT" is selected for "Class" and simple type is selected for "Data Type".	128								
Device	Set a specific device to be assigned to the label when "VAR_GLOBAL" is selected for "Class".	50								
Address	<ul style="list-style-type: none"> <li>• When a device name is entered to either column, the other column is displayed in the respective format automatically.</li> <li>• When the "Device" column is blank, a device is automatically assigned.</li> <li>• When the data type is structure, click the "Detail Setting" cell and set devices on the <u>Structure Device Setting</u> screen. ( Section 5.6.3)</li> </ul>									
comment* <sup>1</sup> , * <sup>2</sup>	Enter a label comment. Comments can be displayed on the program editor by switching display/hide of comments. (  Section 8.7.4)	1024								
Remark* <sup>1</sup> , * <sup>2</sup>	Enter supplementary information for label comments. This item is not displayed on the program editor.	1024								
Relation with System Label* <sup>3</sup>	Display the relation between the global label and system label.									
	<table border="1"> <thead> <tr> <th>Class</th> <th>Description</th> </tr> </thead> <tbody> <tr> <td>Disclose</td> <td>The global label is disclosed as a system label.</td> </tr> <tr> <td>Browse</td> <td>The global label refers the system label which is disclosed by another project.</td> </tr> <tr> <td>Blank</td> <td>There is no relation with a system label.</td> </tr> </tbody> </table>	Class	Description	Disclose	The global label is disclosed as a system label.	Browse	The global label refers the system label which is disclosed by another project.	Blank	There is no relation with a system label.	-
	Class	Description								
	Disclose	The global label is disclosed as a system label.								
Browse	The global label refers the system label which is disclosed by another project.									
Blank	There is no relation with a system label.									
Disclose	The global label is disclosed as a system label.									
Browse	The global label refers the system label which is disclosed by another project.									
Blank	There is no relation with a system label.									
System Label Name* <sup>3</sup>	Display the name of the system label which relates to the global label.	-								
Attribute* <sup>3</sup>	Display the attribute of the system label which relates to the global label.	-								

\*1 : A new line can be inserted into a cell by pressing the  +  keys.

\*2 : The compilation is not necessary after editing.

\*3 : For FXCPU, these items are supported by FX3G, FX3GC, FX3U, and FX3UC only.

## Screen button

- **Reservation to Register System Label** (For FXCPU, this button is supported by FX3G, FX3GC, FX3U, and FX3UC only.)  
Reserves the selected global label for registration as a system label.
- **Reservation to Release System Label** (For FXCPU, this button is supported by FX3G, FX3GC, FX3U, and FX3UC only.)  
Reserves the selected global label for deregistration of system label.  
After the deregistration of the system label is confirmed, the global label becomes a normal global label.
- **Import System Label** (For FXCPU, this button is supported by FX3G, FX3GC, FX3U, and FX3UC only.)  
Imports system labels to the project.

## Operating procedure

1. Click the **Import System Label** button.  
The Import System Labels to Project screen is displayed.

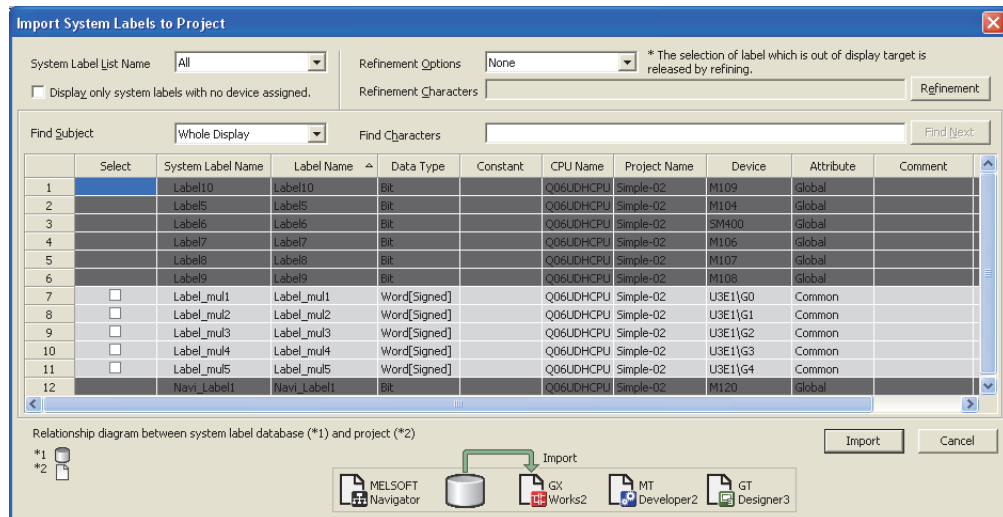

2. Select the check box(es) of "Select" of a system label to import to the project.
3. Click the **Import** button.
4. The following message is displayed.

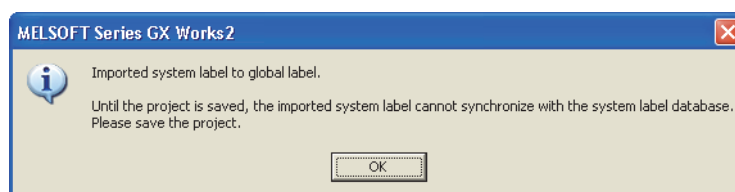

5. Click the **OK** button.

Reflect to  
System Label  
Database

- (For FXCPU, this button is supported by FX3G, FX3GC, FX3U, and FX3UC only.) Applies the registration-reserved/deregistration-reserved system label information to the system label data base, and confirm the registration/deregistration.

## Operating procedure

Reflect to  
System Label  
Database

1. Click the **Reflect to System Label Database** button.

The following message is displayed.

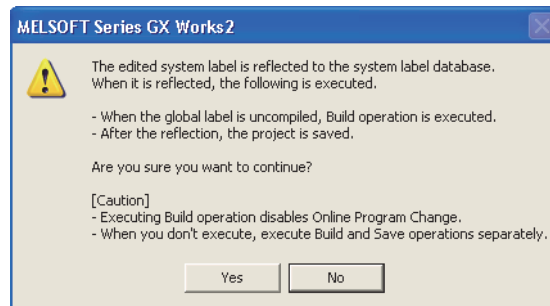

2. Click the **Yes** button.

The build and the save functions are performed automatically.

3. The **Check before registering in system label database** screen is displayed.

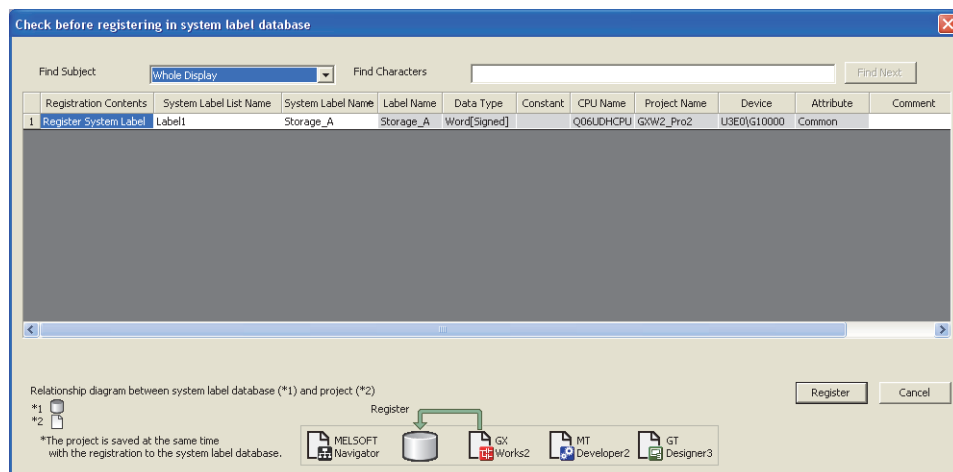

4. Confirm the registration information, and click the **Register** button.

After the system label information is applied to the system label data base, the icon displayed on the Global Label Setting screen is updated to indicate the number of items that are not updated and the updated results as shown below.

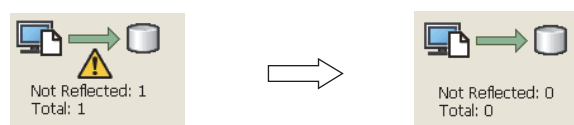

## Point

### ● Class setting

When an item other than the class, such as a label name and data type, is set in a blank column, "VAR\_GLOBAL" is automatically set for "Class". Change it if necessary.

### ● Characters that cannot be used for label names

Any of the following label names causes an error at compilation.

- A label name that includes a space.
- A label name that begins with a numeral.
- A label name which is same as the one used for devices. (For Structured Ladder/FBD and ST programs, lower case device names can be used as labels by setting the option.  Section 10.4.4)

For details, refer to the following manual.

 GX Works2 Version 1 Operating Manual (Common)

### ● Specifying devices/addresses

The digit-specified bit device (K4M0) or bit-specified word device (D0.1) can be specified for devices/addresses.

### ● Using extended data registers (D) or extended link registers (W)

When assigning a data register (D) or a link data register (W) to a global label, set it not to overlap the border between the internal user device and the extended data register (D)/extended link register (W).

### ● Specifying timer/counter devices

When "Data Type" is a bit type, specified devices are treated as contacts (TS, STS, CS).

When "Data Type" is a word type, specified devices are treated as current values (TN, STN, CN).

### ● Assigning devices automatically

Devices are automatically assigned to labels which are not set devices when compiling a program. The device assignment range can be changed on the Device/Label Automatic-Assign Setting screen. ( Section 5.8)

The assigned devices can be checked with the cross reference function.

( GX Works2 Version 1 Operating Manual (Common))

### ● System label

- When performing Online program change, perform the function by selecting [Compile] ⇒ [Online Program Change] and then save the project.

Reflect to  
System Label  
Database

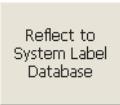
When the  button is clicked after registering, deregistering, or importing system labels, Online program change cannot be performed.

- System labels whose "Attribute" is set to "Common" are not supported by LCPU.
- System labels whose "Attribute" is set to "Common" or "Link" are not supported by FXCPU.
- Importing system labels with MELSOFT Navigator may cause an error at compilation with GX Works2. Check the corresponding error location and correct the error as instructed by the error message displayed on the output window.

## 5.3 Setting Local Labels for Program Blocks

Q CPU L CPU FX

This section explains how to set local labels used for each program block.

### Screen display

Select Project view ⇒ "POU" ⇒ "(program)" ⇒ "(program block)" ⇒ "Local Label".

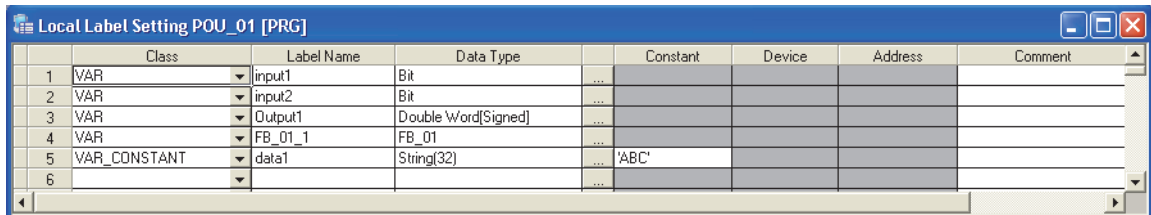

### Operating procedure

- Set the items on the screen.

Item	Description	Maximum number of characters
Class	Select a label class from the list displayed by clicking . ( Section 5.5.1)	-
Label Name	Enter a desired label name.	Ladder/ST/SFC/ Structured Ladder/FBD: 32 (FB instance name: 16)
Data Type	Specify a data type from the <u>Data Type Selection</u> screen displayed by clicking . ( Section 5.5.3) It can also be entered directly.	128
Constant	Enter a constant value when "VAR_CONSTANT" is selected for "Class" and simple type is selected for "Data Type".	128
Device	This item cannot be set for local labels.	
Address	When the data type is structure, click the "Detail Setting" cell and set devices on the <u>Structure Device Setting</u> screen. ( Section 5.6.3)	-
Comment*1, *2	Enter a comment. Comments can be displayed on the program editor by switching display/hide of comments. ( Section 8.7.4)	1024

\*1: A new line can be inserted in a cell by pressing the + keys.

\*2: The compilation is not necessary after editing.

**Point**● **Class setting**

When an item other than the class, such as a label name and data type, is set in a blank column, "VAR" is automatically set for "Class". Change it if necessary.

● **Characters that cannot be used for label names**

Any of the following label names causes an error at compilation.

- A label name that includes a space.
- A label name that begins with a numeral.
- A label name which is same as the one used for devices. (For Structured Ladder/FBD and ST programs, lower case device names can be used as labels by setting the option.  Section 10.4.4)

For details, refer to the following manual.

 GX Works2 Version 1 Operating Manual (Common)

● **Assigning devices automatically**

Devices are automatically assigned to labels when a program is compiled. The device assignment range can be changed on the Device/Label Automatic-Assign Setting screen. ( Section 5.8)

The assigned devices can be checked with the cross reference function.  
( GX Works2 Version 1 Operating Manual (Common))

1  
OVERVIEW2  
SCREEN  
CONFIGURATION3  
PROGRAMMING  
PROCEDURE4  
PROGRAM  
CONFIGURATIONS5  
SETTING LABELS6  
COMMON  
OPERATIONS OF  
PROGRAM EDITORS7  
EDITING ST  
PROGRAMS8  
EDITING STRUCTURED  
LADDER/FBD  
PROGRAMS

## 5.4 Setting Labels for Functions and Function Blocks

Q CPU L CPU FX

This section explains how to set local labels for each function or function block.

Create a new function or function block in advance.

For the method for creating new functions or function blocks, refer to the following manual.

 GX Works2 Version 1 Operating Manual (Common)



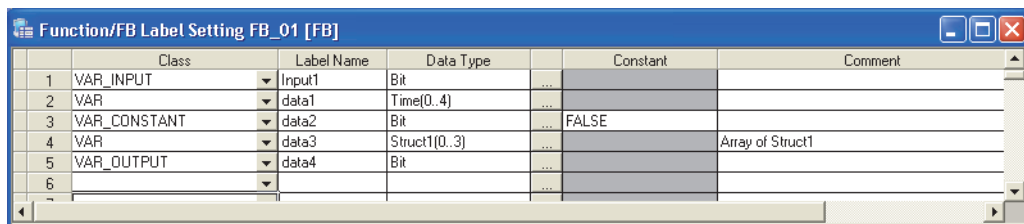

### Screen display



Select Project view ⇒ "POU" ⇒ "FB/FUN" ⇒ "(function/function block)" ⇒ "Local Label".



### Operating procedure

- Set the items on the screen.

Item	Description	Maximum number of characters
Class	Select a label class from the list displayed by clicking  .	-
Label Name	Enter a desired label name.	Ladder/ST/SFC/ Structured Ladder/FBD: 32 (FB instance name: 16)
Data Type	Specify a data type from the <u>Data Type Selection</u> screen displayed by clicking  . (  Section 5.5.3) It can also be entered directly.	128
Constant	Enter a constant value when "VAR_CONSTANT" is selected for "Class" and simple type is selected for "Data Type".	128
Comment*1, *2	Enter a comment. Comments can be displayed on the program editor by switching display/hide of comments. (  Section 8.7.4)	1024

\*1 : A new line can be inserted in a cell by pressing the  +  keys.

\*2 : The compilation is not necessary after editing.



**Point**

● **Class setting**

When an item other than the class, such as a label name and data type, is set in a blank column, "VAR" is automatically set for "Class". Change it if necessary.

● **Characters that cannot be used for label names**

Any of the following label names causes an error at compilation.

- A label name that includes a space.
- A label name that begins with a numeral.
- A label name which is same as the one used for devices. (For Structured Ladder/FBD and ST programs, lower case device names can be used as labels by setting the option. [☞](#) Section 10.4.4)

For details, refer to the following manual.

[☞](#) GX Works2 Version 1 Operating Manual (Common)

● **Assigning devices automatically**

Devices are automatically assigned to labels when a program is compiled. The device assignment range can be changed on the Device/Label Automatic-Assign Setting screen. ([☞](#) Section 5.8)

The assigned devices can be checked with the cross reference function.

([☞](#) GX Works2 Version 1 Operating Manual (Common))

● **Return value of function**

VAR\_OUTPUT cannot be set in a function.

Program the function names as labels in a function to set a return value.

Setting function names as labels is not necessary. Data type set on "Result Type" can be used.

Example: Set return value of function name "FUN\_01" to 0

<Structured Ladder/FBD>

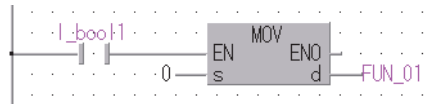

<ST>

FUN\_01 := 0;

■ **Maximum number of input/output labels**

The maximum number of input/output labels can be used in a function/a function block differs according to programming languages.

When setting input/output labels with local label setting of function/function block, set within the number of the input/output labels shown in the following table.

Programming language	Function	Function Blocks	
	Input	Input	Output
Ladder Diagram	-	1 to 24*1 (Including input/output labels)	1 to 24*1 (Including input/output labels)
Structured Ladder/FBD or Structured Text	0 to 253	0 to 253 (Including input/output labels)	

\*1 : The input/output label is counted that each of input /output labels is one label.

1	OVERVIEW
2	SCREEN CONFIGURATION
3	PROGRAMMING PROCEDURE
4	PROGRAM CONFIGURATIONS
5	SETTING LABELS
6	COMMON OPERATIONS OF PROGRAM EDITORS
7	EDITING ST PROGRAMS
8	EDITING STRUCTURED LADDER/FBD PROGRAMS

## 5.5 Common Operations for Setting Labels

Q CPU L CPU FX

This section explains the common operations for each label setting editor.

### 5.5.1 Classes

A label class indicates the POU applicability and the usage of label. Selectable classes differ according to the type of label setting editor. The following table shows selectable classes for each label setting editor.

○: Applicable, ×: Not applicable

Class	Description	Editor to set labels			
		Global label	Local label of a program block	Local label of a function	Local label of a function block
VAR_GLOBAL	Select this class to make a label usable in the program blocks and function blocks commonly in the project.	○	×	×	×
VAR_GLOBAL_CONSTANT	Select this class to make a label with a constant value usable in the program blocks and function blocks commonly in the project.	○	×	×	×
VAR	Select this class to make a label usable in the program block or function/function block.	×	○	○	○
VAR_CONSTANT	Select this class to make a label with a constant value usable in the program block or function/function block.	×	○	○	○
VAR_RETAIN*1	Select this class to make a latch type label usable in the program block or function block.	×	○	×	○
VAR_INPUT	Select this class to make a label usable for input variables in the function/function block. Its value cannot be changed in a POU.	×	×	○	○
VAR_OUTPUT	Select this class to make a label usable for output variables in the function block.	×	×	×	○
VAR_IN_OUT	Select this class to make a label usable for both input and output variables in the function block. Its value can be changed in a POU.	×	×	×	○

\*1 : Not supported by FXCPU.

## 5.5.2 Data types

Data types of label are described in the following table.

For details such as value ranges of each data type, refer to the following manuals.

☞ MELSEC-Q/L/F Structured Programming Manual (Fundamentals)

☞ MELSEC-Q/L Programming Manual (Common Instruction)

☞ User's Manual (Function Explanation, Program Fundamentals) of the CPU module to be used.

Note that data types differ according to the programming language (Ladder Diagram, Sequential Function Chart, Structured Text, Structured Ladder/FBD).

The following table shows data types that can be used for each programming language.

○: Applicable, ×: Not applicable

Data Type	Programming language	
	Ladder Diagram/ Sequential Function Chart	Structured Text/ Structured Ladder/FBD
Bit	○	○
Word (signed)	○	○
Double word (signed)	○	○
Word (unsigned)/16-bit string	×	○
Double word (unsigned)/32-bit string	×	○
Single-precision real*1	○	○
Double-precision real*2	○	○
String*3	○	○
Time	×	○
Timer	○*4	×
Counter	○*4	×
Retentive timer*5	○*4	×
Pointer	○*4	×

\*1: For FXCPU, this item is supported by FX2N, FX2NC, FX3S, FX3G, FX3GC, FX3U, and FX3UC only.

\*2: Supported by Universal model QCPU/LCPU only.

\*3: For FXCPU, this item is supported by FX3U and FX3UC only.

\*4: For Ladder Diagram, these items cannot be used for inline structured text.

\*5: For FXCPU, this item is supported by FX1N, FX1NC, FX2N, FX2NC, FX3S, FX3G, FX3GC, FX3U, and FX3UC only.

1  
OVERVIEW2  
SCREEN  
CONFIGURATION3  
PROGRAMMING  
PROCEDURE4  
PROGRAM  
CONFIGURATIONS5  
SETTING LABELS6  
COMMON  
OPERATIONS OF  
PROGRAM EDITORS7  
EDITING ST  
PROGRAMS8  
EDITING STRUCTURED  
LADDER/FBD  
PROGRAMS

### 5.5.3 Selecting data types

Select a data type.

A data type can be selected on the Data Type Selection screen other than direct data entry.

#### Screen display

Click  on the data type entry field on each label setting editor.

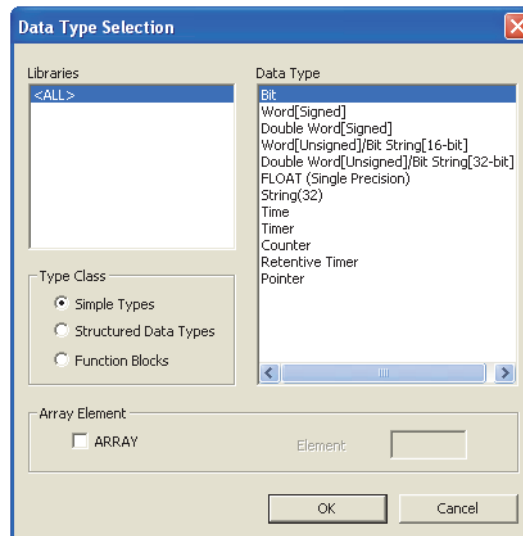

#### Operating procedure

##### 1. Select a type for "Type Class".

Item	Description
Simple Types	Specify this to select a data type from basic types such as bit and word.
Structured Data Types	Specify this to select a data type from the defined structures. (Grayed out for structure settings)
Function Blocks	Specify this to select a data type from the defined function blocks. (Grayed out for structure settings)

##### 2. On the "Libraries" field, select the reference source such as the defined structure that is used as the data type.

Item	Description
<ALL>	Browse data types and structures/function blocks defined in the project, and all libraries.
<Project>	Browse structures/function blocks defined in the project. (Not displayed when "Simple Types" is selected.)
Standard Lib.	Browse function blocks of the application functions. (Not displayed when "Simple Types" or "Structured Data Types" is selected.)

##### 3. On the "Data Type" field, select the data type, structure, or function block name.

##### 4. Click the button when the setting is completed.

The settings are displayed on the "Data Type" column on the label setting editor.

**Point**

● **Method for displaying the Data Type Selection screen**

The Data Type Selection screen can be opened by any of the following operations when  is in the selected status.

- Press the  key.
- Press the  key.
- Press the  key.

■ **Setting arrays for data type**

Define a data type as an array.

To define a data type as an array, set the items of "Array Element" on the Data Type Selection screen.

**Operation**

1. Click  on the data type entry field on each label setting editor.
2. Select "ARRAY" under "Array Element".
3. Enter the number of elements for "Element".
4. Set the data type of the array element in the same manner as setting the normal data type.

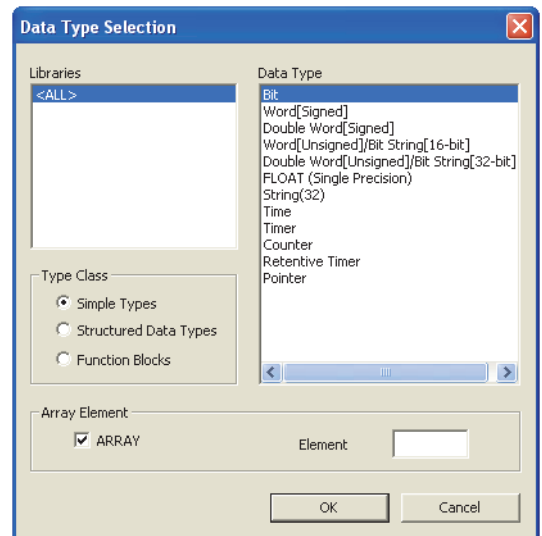

● **To change the offset**

To change the offset ([Array start value]..[Array end value]) to a value other than 0, edit the offset value by directly entering the array declaration in text on each label setting editor.

	Class	Label Name	Data Type
1	VAR	data1	Bit(0..2)
2	VAR	data2	Word(Unsigned)/Bit(16Bit)(1..2)
3	VAR	data3	Struct1(0..4)

1	OVERVIEW
2	SCREEN CONFIGURATION
3	PROGRAMMING PROCEDURE
4	PROGRAM CONFIGURATIONS
5	SETTING LABELS
6	COMMON OPERATIONS OF PROGRAM EDITORS
7	EDITING ST PROGRAMS
8	EDITING STRUCTURED LADDER/FBD PROGRAMS

### ● To change the array to a two- or three-dimensional array

Edit two- or three-dimensional array by directly entering the array declaration in text on each label setting editor.

For details on array declarations, refer to the following manual.

📖 MELSEC-Q/L/F Structured Programming Manual (Fundamentals)

	Class	Label Name	Data Type
1	VAR	data1	Bit[0..2,0..4]
2	VAR	data2	Word[Unsigned]/Bit[16Bit][0..4,0..1..2]
3	VAR	data3	Struct1[1..5,0..1]

### Point

#### ● When a constant type is set for class

For labels whose classes are set as VAR\_CONSTANT or VAR\_GLOBAL\_CONSTANT, arrays cannot be set for the data type. If they are set, an error occurs at compilation.

#### ● Offset values

Minus values can be set for offset values.

#### ● Digit specification of labels

In the Structured Ladder/FBD program and the Structured Text program, digit specification of labels (K4label1, for example) is applicable.

Define the data type of the labels to be digit-specified as a bit type array.

However, structure labels cannot be specified. (SDT1, K4label1, etc.)

In addition, the digit-specified labels cannot be used in the following functions:

- Cross reference
- Find/Replace device
- Device batch replace
- Device test with execution condition
- Sampling trace

## ■ Setting data length of the character string data type

To change the data length of the character string data type, directly edit the data length on each label setting editor.

The initial value of data length of the character string data type is set on the option setting.

### ● Changing data length on the label setting editor

#### Operation

- Change the data length on the "Data Type" column on the label setting editor.

	Class	Label Name	Data Type
1	VAR	L_string1	String(32)
2	VAR	L_string2	String(16)

Change these values directly.

### ● Changing initial value of data length

#### Operation

- Select [Tool] ⇒ [Options] ⇒ "Label Setting Editor" ⇒ "Default Length of String Data Type", and set the data length.

Data Type Setting

Default Length of String Data Type

## 5.5.4 Label comments

Append a comment to a defined label.

Label comments can be displayed on the Structured Ladder editor.

Select [View] ⇒ [View Mode] ⇒ [Comment] to display label comments.

Label comments are not applied to device comments even when a program is compiled.

## 5.5.5 Editing rows

Edit rows on the label setting editor.

### ■ Adding rows

Add a row on the label setting editor.

#### ● New Declaration (Before)

Insert a row above the selected row.

#### Operation

- Select [Edit] ⇒ [New Declaration (Before)] (  ).

	Class	Label Name
1	VAR_INPUT	in_data
2	VAR	data1
3	VAR_CONSTANT	data2

→

	Class	Label Name
1		
2	VAR_INPUT	in_data
3	VAR	data1

#### ● New Declaration (After)

Insert a row below the selected row.

#### Operation

- Select [Edit] ⇒ [New Declaration (After)] (  ).

	Class	Label Name
1	VAR_INPUT	in_data
2	VAR	data1
3	VAR_CONSTANT	data2

→

	Class	Label Name
1	VAR_INPUT	in_data
2	VAR_INPUT	in_data1
3	VAR	data1
4	VAR_CONSTANT	data2

#### Point

#### ● New Declaration (After)

The following settings can be set with the New Declaration (After) function.

Set whether to leave cells of added row blank.

Enter label names or data types automatically.

Select [Tool] ⇒ [Options] ⇒ "Label Setting Editor" ⇒ "Editor Setting".

Editor Setting	
<input checked="" type="checkbox"/>	Automatic copy and increment when inserting a row
<input checked="" type="checkbox"/>	Copy data type/comment items

- When "Automatic copy and increment when inserting a row" is selected  
Copy the class and label name, append a value after the label name, and add a row with the copied data below the specified row. If a value is already appended after the label name, the data is copied with an incremented value. When devices are set for global labels, the data is copied with an incremented device number.
- When "Copy data type/comment items" is selected  
Copy the data type, comment, and remark, and add a row with the copied data below the specified row.

## ■ Deleting rows

Delete a row on the label setting editor.

### Operation

- Select [Edit] ⇒ [Delete Row] (  ).

	Class	Label Name
1	VAR_INPUT	In_data
2	VAR	data1
3	VAR_CONSTANT	data2

→

	Class	Label Name
1	VAR	data1
2	VAR_CONSTANT	data2
3	VAR	data3

## ■ Displaying all lines or first line of comments and remarks

For the "Comment" and "Remark" columns, data can be entered in multiple lines. The 'all lines/first line display' function switches the display between all lines and only the first line by double-clicking "+" or "-".

### ● All lines display

Display all lines of information on the "Comment" and "Remark" columns.

### Operation

- Double-click "+" on the row number cell of the table.

### ● First line display

Display only the first line of information on the "Comment" and "Remark" columns.

### Operation

- Double-click "-" on the row number cell of the table.

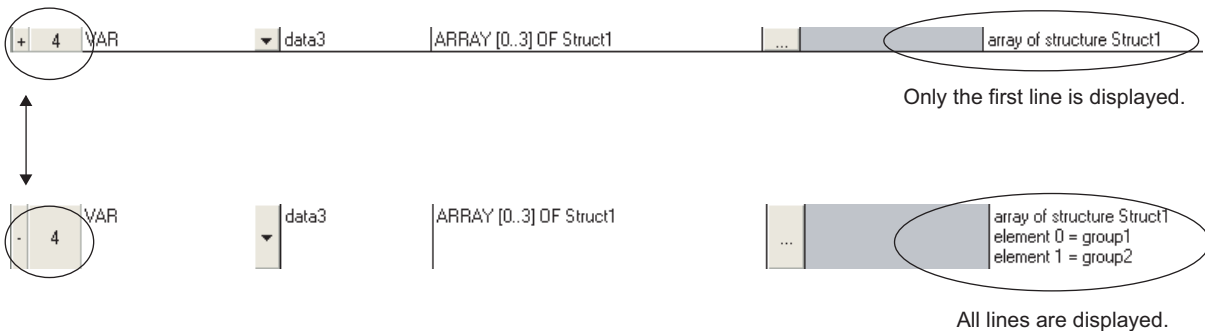

The diagram illustrates the toggle between displaying only the first line of a comment and displaying all lines. In the top part, a table row for 'VAR' with label 'data3' and data type 'ARRAY [0..3] OF Struct1' is shown. The comment field contains 'array of structure Struct1'. A '+' sign in the row number cell (4) is circled, and the text 'Only the first line is displayed.' is shown below. A double-headed vertical arrow indicates the transition to the bottom part, where the '-' sign in the row number cell (4) is circled, and the text 'All lines are displayed.' is shown below. The comment field now displays 'array of structure Struct1' followed by 'element 0 = group1' and 'element 1 = group2' on separate lines.

## ■ Selecting all rows

All rows can be selected by the following operation.

### Operation

- Select [Edit] ⇒ [Select All].

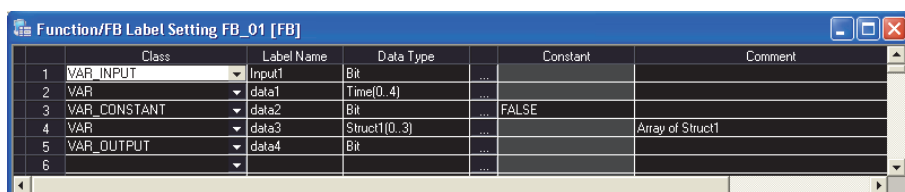

The screenshot shows the 'Function/FB Label Setting FB\_01 [FB]' window. The table below has all rows selected, indicated by a dark background for each row.

	Class	Label Name	Data Type	Constant	Comment
1	VAR_INPUT	Input1	Bit	...	
2	VAR	data1	Time[0..4]	...	
3	VAR_CONSTANT	data2	Bit	FALSE	
4	VAR	data3	Struct1[0..3]	...	Array of Struct1
5	VAR_OUTPUT	data4	Bit	...	
6				...	



## ■ Sorting labels

Sort the labels in ascending/descending order by selecting a label item.  
Applicable to only local labels of program and global labels.

### Operation

1. Select [Edit] ⇒ [Sort] ⇒ [Class]/[Label Name]/[Data Type]/[Constant]/[Device]/[Address]/[Comment]/[Remark].  
The following confirmation message is displayed.

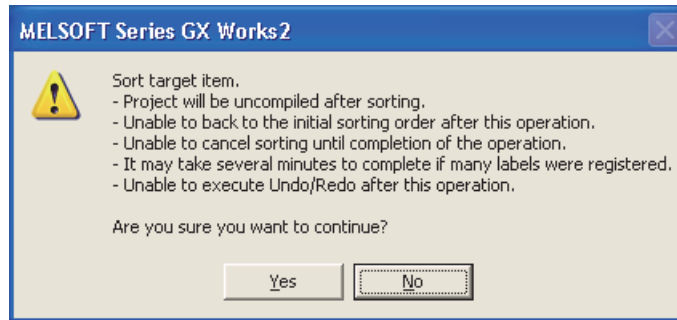

2. Click the **Yes** button.

Sort the selected item in ascending order. is displayed on the title name for ascending order.  
For descending order, select the same item again. is displayed on the title name for descending order.

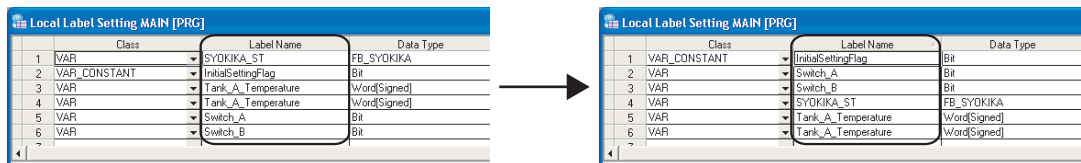

### Point

#### ● Sorting labels with label setting editor

Labels can be also sorted by clicking a title name of label setting editor.

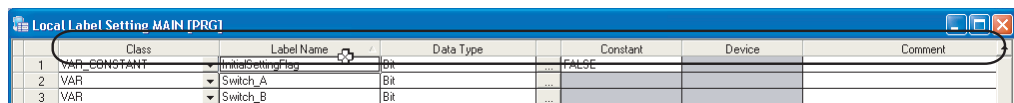

#### ● Considerations for sorting labels

The following are the considerations for sorting labels.

- After sorting labels, the programs relating to the sorted labels are in the uncompiled status.
- After sorting labels, [Edit] ⇒ [Undo]/[Redo] cannot be selected.

## ■ Displaying one last blank row only

Display only one blank row under the label of last row on the label setting editor.  
Applicable to only local labels of program and global labels.

### Operation

- Select [Tool] ⇒ [Options] ⇒ "Label Setting Editor", and select "Display last blank row".  
Only one blank row is displayed under the label of last row.

	Class	Label Name	Da
5115	VAR	CompleteFlag06	Bit
5116	VAR	CompleteFlag07	Bit
5117			
5118			
5119			
5120			

	Class	Label Name	Da
5112	VAR	CompleteFlag03	Bit
5113	VAR	CompleteFlag04	Bit
5114	VAR	CompleteFlag05	Bit
5115	VAR	CompleteFlag06	Bit
5116	VAR	CompleteFlag07	Bit
5117			

### Point

#### ● Operation for editing rows

When the cursor is on the last blank row on the label setting editor, [Edit] ⇒ [New Declaration (Before)]/[New Declaration (After)]/[Delete Line] cannot be selected.

Select a row other than the last row for adding or deleting rows.

#### ● Adding rows under the last row where a label is set

When "Automatic copy and increment when inserting a row" is not set under [Tool] ⇒ [Options] ⇒ "Label Setting Editor", executing the New Declaration (After) function on the last row where a label is set adds a row with class. "VAR\_GLOBAL" for global label, "VAR" for local label is set. Change it if necessary.

## 5.5.6 Deleting unused labels

Extract unused labels from the set labels on the label setting editor, and delete them in batch. Unused labels are searched from the cross reference information.  
Target labels for this operation are local labels in programs of POU and global labels.

### Operating procedure

#### 1. Select [Edit] ⇒ [Unused label list].

The following message is displayed.

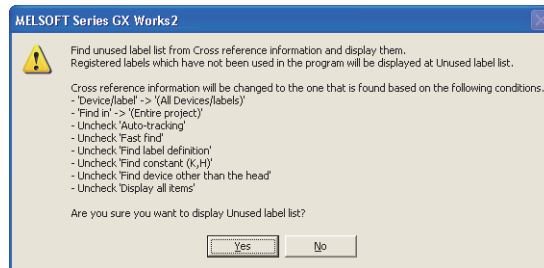

#### 2. Click the **Yes** button.

The unused labels are extracted.

#### 3. The **Unused label list** screen is displayed.

Select unused labels to be deleted under "Label name".

Click the **Select all** button to select all unused labels.

Click the **Cancel All Selections** button to cancel the selection of all unused labels.

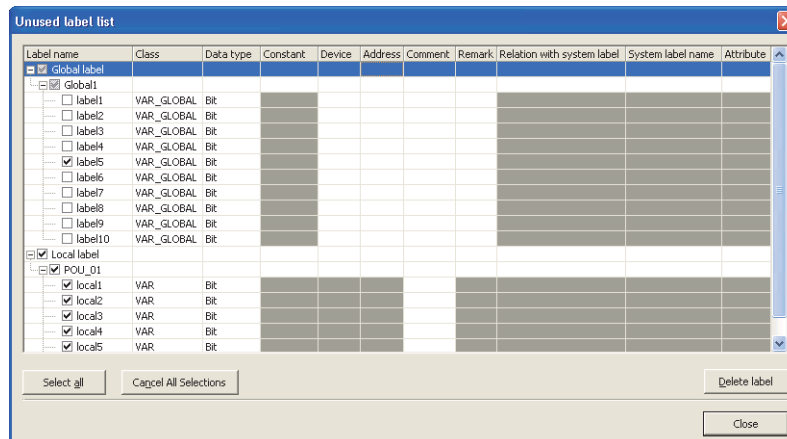

#### 4. Click the **Delete label** button.

The following message is displayed.

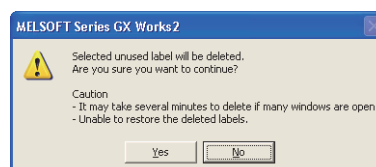

**5. Click the  button.**

The selected unused labels are deleted.

The program becomes uncompiled status after the unused labels are deleted, however, the operation to delete unused labels can be continued while the Unused label list screen is being displayed.

**Point****● Considerations when deleting unused labels**

The following are the considerations when deleting unused labels.

- After unused labels are deleted, programs related to the deleted unused labels become uncompiled status.
- The [Undo]/[Redo] operation under [Edit] cannot be selected after unused labels are deleted.
- Labels in user libraries and functions/function blocks are not displayed on the Unused label list screen.
- When "Create cross reference information after completion compile" is selected under [Tool] ⇒ [Options] ⇒ "Compile" ⇒ "Basic Setting", the Unused label list screen cannot be displayed.

## 5.6 Setting Structure Labels

Q CPU L CPU FX

This section explains how to set structure labels.

### 5.6.1 Setting structures

Set the elements of the structure on the Structure Setting screen.

#### Screen display

Select Project view ⇒ "POU" ⇒ "Structured Data Types" ⇒ "(structure)".

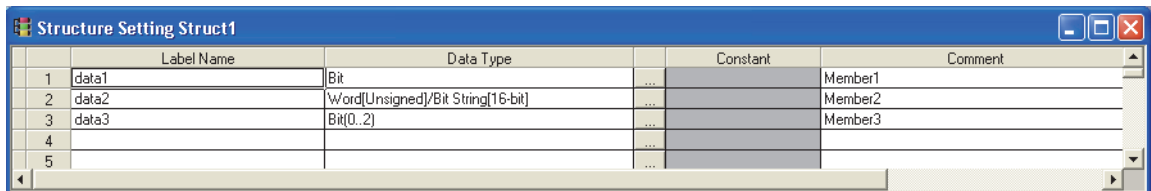

#### Operating procedure

- Set the items on the screen.

Item	Description	Maximum number of characters
Label Name	Enter a desired label name.	32
Data Type	Set a data type from the <u>Data Type Selection</u> screen displayed by clicking <input type="button" value="..."/> . (☞ Section 5.5.3) It can also be entered directly.	128
Constant	Constant values are not displayed on the <u>Structure Setting</u> screen.	128
comment* <sup>1</sup> , * <sup>2</sup>	Enter a comment. Comments can be displayed on the program editor by switching display/hide of comments. (☞ Section 8.7.4)	1024

\*1 : A new line can be inserted in a cell by pressing the  +  keys.

\*2 : The compilation is not necessary after editing.

#### Point

- **Creating new structure data**

Create structure data using the Project view.

(☞ GX Works2 Version 1 Operating Manual (Common))

- **When registering structure to the data type of system label**

Elements of the structure registered to the data type of system label cannot be edited.

Elements of structure can be added and comments can be edited.

However, when the edited information is applied to the system label data base, all references of the system labels which use the edited structure are deregistered. Register the canceled system labels again.

## 5.6.2 Defining data type of label as structure

---

To define the data type of label as a structure, set a structure in the data type entry field on each label setting editor. In addition to direct text entry, a structure can be selected on the [Data Type Selection](#) screen. (☞ Section 5.5.3)

### 5.6.3 Assigning devices to structure labels

Devices of the structure global labels are set on the Structure Device Setting screen. If a structure is set for data type on the Global Label Setting screen, "Detail Setting" is displayed on the "Device" and "Address" columns. Click "Detail Setting" to display the Structure Device Setting screen.

#### Screen display

Click "Detail Setting" on the label setting editor.

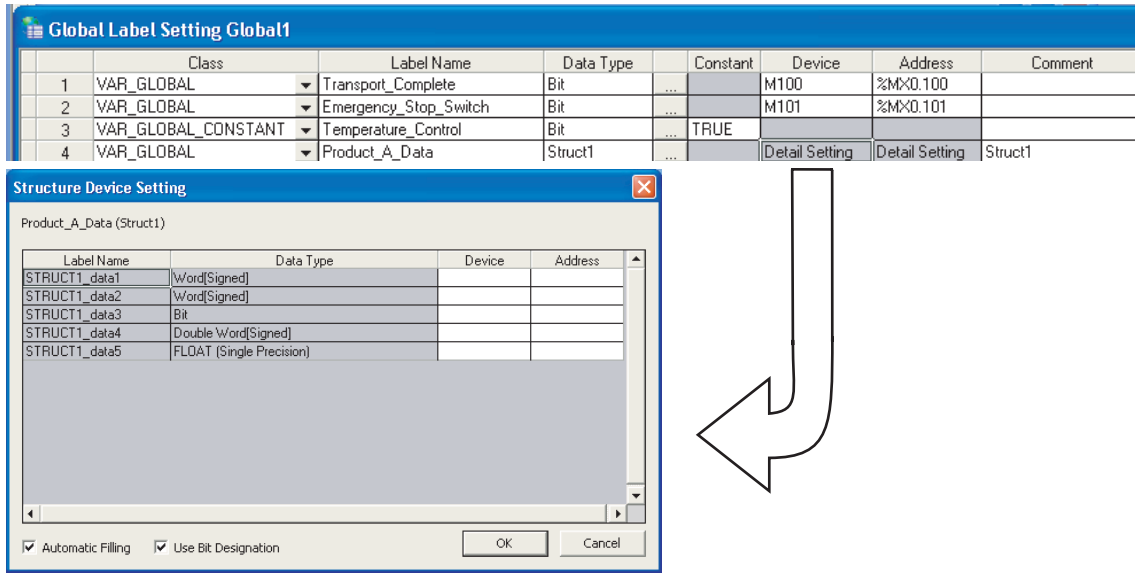

#### Operating procedure

- Set the items on the screen.

Item	Description
Label Name	Display label names defined in the structure.
Data Type	Display data types set to data names.
Device	Set device names to be assigned in the "Device" or "Address" column. (When a device name is entered in either column, it is displayed in the respective format automatically.)
Address	
Automatic Filling	Select this to set devices automatically to cells in which devices are not set with the same data type.
Use Bit Designation	Select this to enter bit devices automatically with the bit-specified word device.

#### Point

- **Display on the Local Label Setting screen**  
For the Structure Device Setting screen, the read-only screen is displayed.
- **Setting devices of global labels**  
Devices assigned to structure are not cleared even when elements of structure are changed on the Structure Setting screen.  
However, devices of member whose data type is changed or devices of member whose data type is changed to the one with different bit array are cleared.

1	OVERVIEW
2	SCREEN CONFIGURATION
3	PROGRAMMING PROCEDURE
4	PROGRAM CONFIGURATIONS
5	SETTING LABELS
6	COMMON OPERATIONS OF PROGRAM EDITORS
7	EDITING ST PROGRAMS
8	EDITING STRUCTURED LADDER/FBD PROGRAMS

## ■ Entering device names automatically

The Automatic filling function can be used when setting series of devices for the data on the Structure Device Setting screen.

When using the Automatic filling function, whether to use bit specification of word device can be selected.

### Operation

#### 1. Click "Detail Setting" on the label setting editor.

The Structure Device Setting screen is displayed.

#### 2. Enter the device name to the Device/Address column.

Series of devices are automatically set in the cells following the one entered, skipping the cells where devices are already set.

#### ● When using bit specification

Label Name	Data Type	Device	Address
STR_A	Double Word[Signed]	D1	
STR_B	Double Word[Signed]		
STR_C	Bit		
STR_D	Bit		
STR_E	Double Word[Signed]		

Enter "D1".

↓

Label Name	Data Type	Device	Address
STR_A	Double Word[Signed]	D1	%MD0.1
STR_B	Double Word[Signed]	D3	%MD0.3
STR_C	Bit	D5.0	%MX0.5.0
STR_D	Bit	D5.1	%MX0.5.1
STR_E	Double Word[Signed]	D6	%MD0.6

Automatically set data

#### ● When not using bit specification

Label Name	Data Type	Device	Address
STR_A	Double Word[Signed]	D1	
STR_B	Double Word[Signed]		
STR_C	Bit		
STR_D	Bit		
STR_E	Double Word[Signed]		

Enter "D1".

↓

Label Name	Data Type	Device	Address
STR_A	Double Word[Signed]	D1	%MD0.1
STR_B	Double Word[Signed]	D3	%MD0.3
STR_C	Bit		
STR_D	Bit		
STR_E	Double Word[Signed]	D5	%MD0.5

Automatically set data

### Point

#### ● When not using bit specification

When the bit specification is not used, clear "Use Bit Designation" on the Structure Device Setting screen.



## 5.6.4 Assigning devices to structure array labels

Set devices for the structure array global labels on the Structure Device Setting screen. When VAR\_GLOBAL is set for "Class" and the structure array is set for "Data Type" on the Global Label Setting screen, "Detail Setting" is displayed on the "Device" and "Address" columns. Click "Detail Setting" to display the Structure Device Setting screen.

### Screen display

Click "Detail Setting" on the label setting editor.

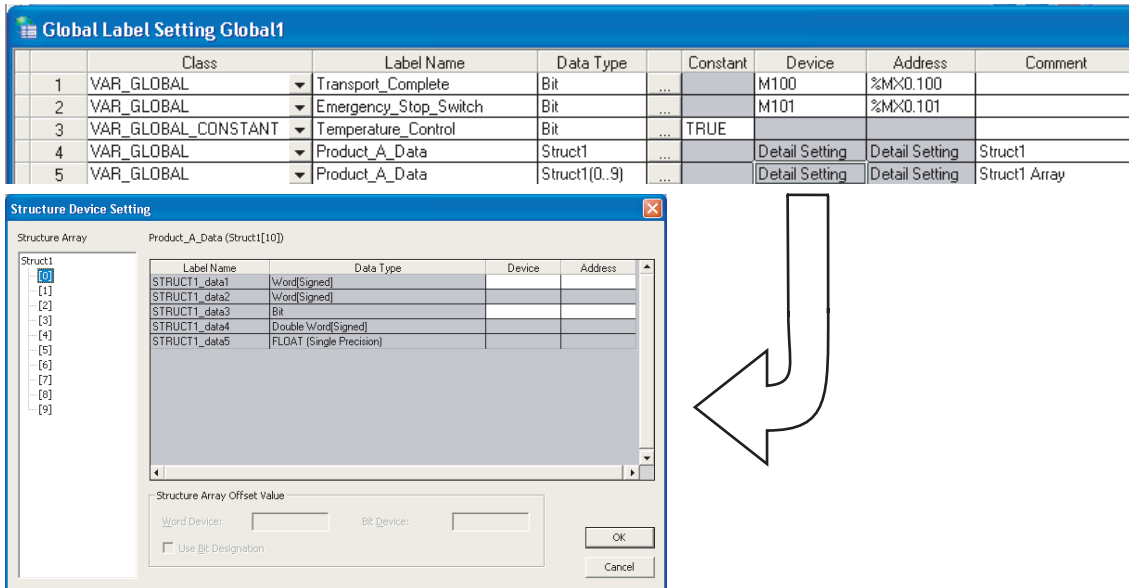

### Operating procedure

- Set the items on the screen.

Item	Description	
Structure Array	Display elements of the structure array in tree format. The device setting of the element selected from the tree is displayed on the right area of the screen.	
Label Name	Display label names defined in the structure.	
Data Type	Display data types set to data names.	
Device	Set device names to be assigned in the "Device" or "Address" column. (When a device name is entered in either column, it is displayed in the respective format automatically.)	
Address	Device names can be entered for the start array element only. For the subsequent array elements, device names offset from the device number set for the start element are automatically set.	
Structure Array Offset Value	Word Device/Bit Device	Specify the device offset value to be set in the array element.
	Use Bit Designation	Select this to set bit devices with the bit-specified word device.

1 OVERVIEW

2 SCREEN CONFIGURATION

3 PROGRAMMING PROCEDURE

4 PROGRAM CONFIGURATIONS

5 SETTING LABELS

6 COMMON OPERATIONS OF PROGRAM EDITORS

7 EDITING ST PROGRAMS

8 EDITING STRUCTURED LADDER/FBD PROGRAMS

**Point**

- **Display on the Local Label Setting screen**

For the Structure Device Setting screen, the read-only screen is displayed.

- **Setting devices of global labels**

Devices assigned to structure are cleared when elements of structure are changed on the Structure Setting screen. However, devices of member whose data type is changed to the one with the same bit array are not cleared.

- **Considerations when using system labels**

Structure array global labels on which "Structure Array Offset Value" is set cannot be registered as a system label.

## ■ Entering device names automatically by setting offset values

On the Structure Device setting screen, device numbers to be entered automatically can be set in fixed spacing for each array element of the structure array. Specify the difference in device numbers between the array elements as an offset value for the start device.

### Operation

1. **Click "Detail Setting" on the label setting editor.**

The Structure Device Setting screen is displayed.

2. **Set the device name to the start element data of the array.**

Devices are set to the data of the same data type on the editing screen and in the subsequent array elements.

· Offset value is not specified.

< Array [0] >

Label Name	Data Type	Device	Address
STR_A	Double Word[Signed]	D1	%MD0.1
STR_B	Double Word[Signed]	D3	%MD0.3
STR_C	Bit	X1	%IX1
STR_D	Bit	X2	%IX2
STR_E	Double Word[Signed]	D5	%MD0.5

Enter "D1".

< Array [1] >

Label Name	Data Type	Device	Address
STR_A	Double Word[Signed]	D7	%MD0.7
STR_B	Double Word[Signed]	D9	%MD0.9
STR_C	Bit	X3	%IX3
STR_D	Bit	X4	%IX4
STR_E	Double Word[Signed]	D11	%MD0.11

Devices starting from "D7" are assigned.

3. **Set "Structure Array Offset Value".**

Structure Array Offset Value

Word Device:       Bit Device:

Use Bit Designation

By setting an offset value, devices to which the offset value is added are set to devices in the subsequent array elements.

- Offset value is 10.

< Array [0] >

Label Name	Data Type	Device	Address
STR_A	Double Word[Signed]	D1	%MD0.1
STR_B	Double Word[Signed]	D3	%MD0.3
STR_C	Bit	X1	%IX1
STR_D	Bit	X2	%IX2
STR_E	Double Word[Signed]	D5	%MD0.5

Enter "D1".

< Array [1] >

Label Name	Data Type	Device	Address
STR_A	Double Word[Signed]	D11	%MD0.11
STR_B	Double Word[Signed]	D13	%MD0.13
STR_C	Bit	X6	%IX6
STR_D	Bit	X7	%IX7
STR_E	Double Word[Signed]	D15	%MD0.15

Devices starting from "D11" are assigned.

### ● Using bit specification

Devices can be set by specifying a bit device of word device when entering devices automatically.

#### Operation

1. Click "Detail Setting" on the label setting editor.  
The Structure Device Setting screen is displayed.
2. Set the device name to the start element word device data of the array.  
Devices are set for the same data type on the editing screen and in the subsequent array elements.
3. Select "Use Bit Designation".  
Bit-specified word devices are set to the bit devices.

Label Name	Data Type	Device	Address
STR_A	Double Word[Signed]	D1	%MD0.1
STR_B	Double Word[Signed]	D3	%MD0.3
STR_C	Bit	D5.0	%MX0.5.0
STR_D	Bit	D5.1	%MX0.5.1
STR_E	Double Word[Signed]	D6	%MD0.6

#### Point

### ● Data for which device name can be entered

For structure arrays, a device name can be entered only for the start element of array.

For the subsequent array elements, device names offset from the device number set for the start element are automatically set.

When the start element is a bit type, the bit-specified word device cannot be set as a device.

### ● Offset values

- An expression such as '1\0' or '0\2' can be specified for an incremental value of device such as U0\G0. However, the incremental values cannot be specified to the both sides of \, such as '1\2'.
- When '0' is specified for the incremental value, the device number same as the data set to the start of devices is set to all data in the array.

## 5.7 Checking Duplications of Devices Assigned to Global Labels

Q CPU L CPU FX

This section explains how to check duplications of devices assigned to global labels. The result of the duplication check is displayed on the Output window.

### ■ Checking duplications of device names

#### Operating procedure

#### 1. Select [Tool] ⇒ [Check Device Duplication of Global Label].

Duplications of device names set on the device columns of the Global Label Setting screen are checked. The result is displayed on the Output window.

#### 2. Double-click the result displayed on the Output window.

The corresponding error location in the program is displayed. The duplicated devices are displayed in red.

For checking duplication results, refer to Section 10.6.

No.	Result	Data Name	Class	Content	Error Code
1	Warning	Global1	Device duplication	Duplication found in devices. (Global1: Row 1: 'Transport_Complete'[M100] and Global1: Row 2: 'Em... Row 1	Row 1

Error: 0, Warning: 1

#### Point

##### ● Device names to be checked for duplications

Character strings set on the device columns of the Global Label Setting screen are checked.

All global label data except for those of user libraries in a project are the target.

Note that, however, if the character strings set on the device columns are not supported by GX Works2, those devices are not checked.

##### ● Corresponding error location of duplication check

When the duplication of device names is found between global labels in single global label file, the device cell with lower row number is displayed.

# 5.8 Setting Ranges for Devices Assigned Automatically

Q CPU L CPU FX

This section explains how to set the ranges for devices that are automatically assigned to labels. The devices set as automatically assigned device are assigned to labels when a program is compiled. (Section 10.5)

## QCPU (Q mode)/LCPU

### Screen display

Select [Tool] ⇒ [Device/Label Automatic-Assign Setting].

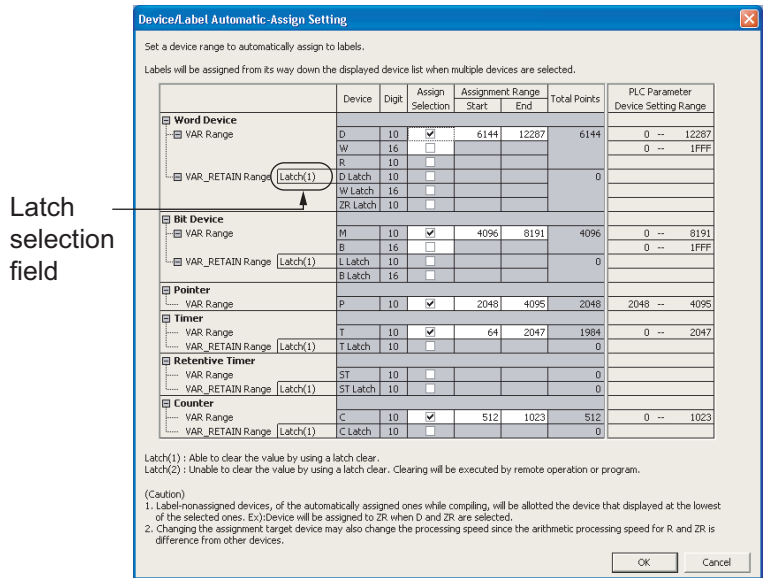

### Operating procedure

- Set the items on the screen.

Item	Description
Latch selection field	Select latch (1) or latch (2). This item can be selected when the range of latch (1), latch (2) is set on the <<Device>> tab of PLC parameter.
Device	Display the devices to be assigned automatically.
Digit	Display whether the range of device assignment setting is in decimal or hexadecimal.
Assign Selection	Select the devices to be assigned automatically. Multiple devices can be set.
Assignment Range	Start End Enter the range of device points to be assigned automatically.
Total Points	Display the total points of each device range for VAR and VAR_RETAIN.
PLC Parameter Device Setting Range	Display the device point range set on the <<Device>> tab of PLC parameter. When the latch range is set, display the device point range with the latch range. Example: When D: 0 to 12287, latch D: 5000 to 6000 are set on the <<Device>> tab of PLC parameter, display range of D: 0 to 12287, range of latch D: 5000 to 6000.

1	OVERVIEW
2	SCREEN CONFIGURATION
3	PROGRAMMING PROCEDURE
4	PROGRAM CONFIGURATIONS
5	SETTING LABELS
6	COMMON OPERATIONS OF PROGRAM EDITORS
7	EDITING ST PROGRAMS
8	EDITING STRUCTURED LADDER/FBD PROGRAMS

## ■ FXCPU

### Screen display

Select [Tool] ⇒ [Device/Label Automatic-Assign Setting].

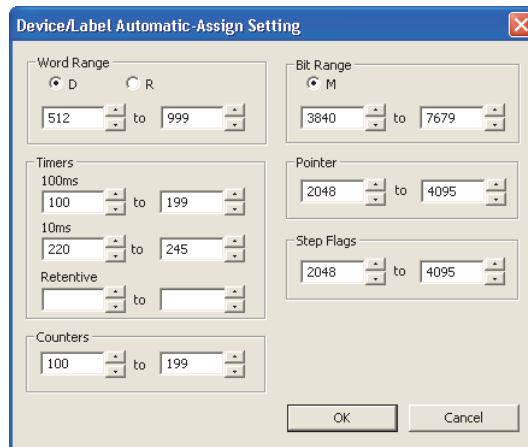

### Operating procedure

- Select the device type, and set the start and end addresses to be assigned automatically.

## 5.8.1 Considerations of automatically assigned devices

### ● Considerations when changing automatically assigned devices

All programs need to be compiled when the range of automatically assigned device is changed. Compiling all programs changes the device assignment to labels. Therefore, device values set before the program change remain on the device-assigned labels.

Perform the following operation as a precautionary measure.

- For QCPU (Q mode)/LCPU  
After writing data to the programmable controller CPU, reset the programmable controller CPU, clear all device memories including latches, clear all file registers, then switch the programmable controller CPU to RUN.
- For FXCPU  
After writing data to the programmable controller CPU, clear the device memory of the programmable controller CPU with the PLC memory clear function, then switch the programmable controller CPU to RUN.

(📖 GX Works2 Version 1 Operating Manual (Common))

For considerations for compiling all programs, refer to Section 10.5.3.

### ● Assigning devices with the "Device/Label Automatic-Assign Setting" function

Assign devices to labels with the "Device/Label Automatic-Assign Setting" function when a program is compiled.

For details, refer to Section 10.5.

The assigned devices can be checked with the cross reference function.

(📖 GX Works2 Version 1 Operating Manual (Common))

Devices within the range set on the Device/Label Automatic-Assign Setting screen cannot be used in a program.

● **Considerations when the multiple types of devices are assigned automatically (QCPU (Q mode)/LCPU)**

Refer to Considerations of compilation. (☞ Section 10.5.3)

● **Device types and setting ranges**

The types of automatically assigned devices differ by the type of CPU.

The setting ranges depend on the number of device points set in PLC parameter.

For details of PLC parameter, refer to the following manual.

☞ GX Works2 Version 1 Operating Manual (Common)

● **Considerations when displaying the Device/Label Automatic-Assign Setting screen**

When displaying the Device/Label Automatic-Assign Setting screen, an error message may be displayed.

In this case, terminate GX Works2, copy "vsflex8n.ocx" stored in the folder of GX Works2 installation destination to "C:\WINDOWS\system32" (for Windows® XP), and restart GX Works2.

● **Timers of Device/Label Automatic-Assign Setting function for FXCPU (100ms, 10ms, retentive timer)**

When a program created with FXCPU is compiled, devices set to "100ms" under "Timers" are automatically assigned to the timer type labels.

For assigning 10ms timer devices or retentive timer devices to the timer type labels, define the global label and specify the device number directly.

Devices set to "10ms" and "Retentive" under "Timers" are used respectively in the following function blocks of FXCPU Structured project in Structured Text or Structured Ladder.

- TIMER\_10\_FB\_M : 10ms timer
- TIMER\_CONT\_FB\_M : Retentive timer

1  
OVERVIEW2  
SCREEN CONFIGURATION3  
PROGRAMMING PROCEDURE4  
PROGRAM CONFIGURATIONS5  
SETTING LABELS6  
COMMON OPERATIONS OF PROGRAM EDITORS7  
EDITING ST PROGRAMS8  
EDITING STRUCTURED LADDER/FBD PROGRAMS

## 5.9 Writing/Reading Data to/from CSV Files

Q CPU L CPU FX

This section explains how to write the label setting data to the CSV file and how to read the label setting data from the CSV file.

### ■ Writing label setting data

Write label setting data to CSV files.

#### Operating procedure

1. Select [Edit] ⇒ [Write to CSV File] (  ).

The following message is displayed.

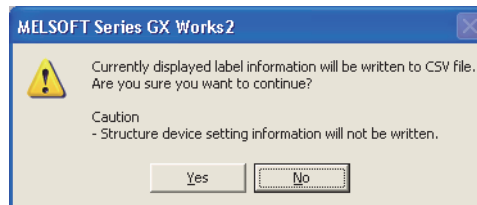

2. Click the  button.

The Write to CSV File screen is displayed.

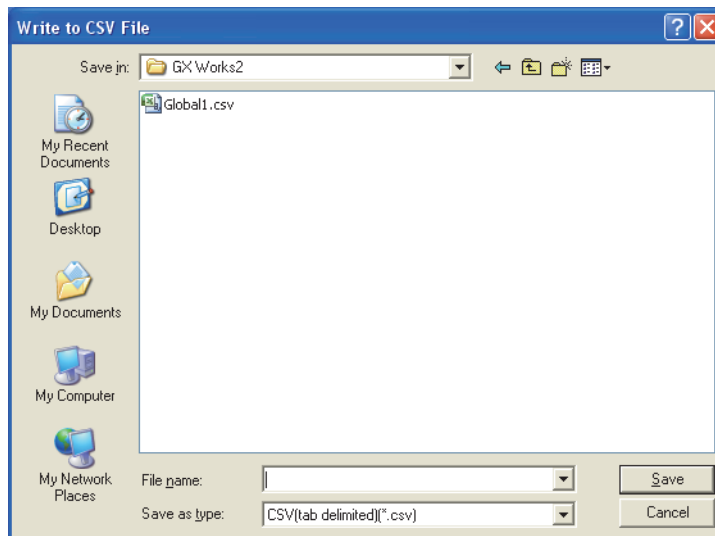

3. Enter the file name to be saved and click the  button.

The label setting data is saved in the save destination.



## ■ Reading label setting data

Read label setting data from CSV files.

### Operating procedure

1. Select [Edit] ⇒ [Read from CSV File] (  ).

The Read from CSV File screen is displayed.

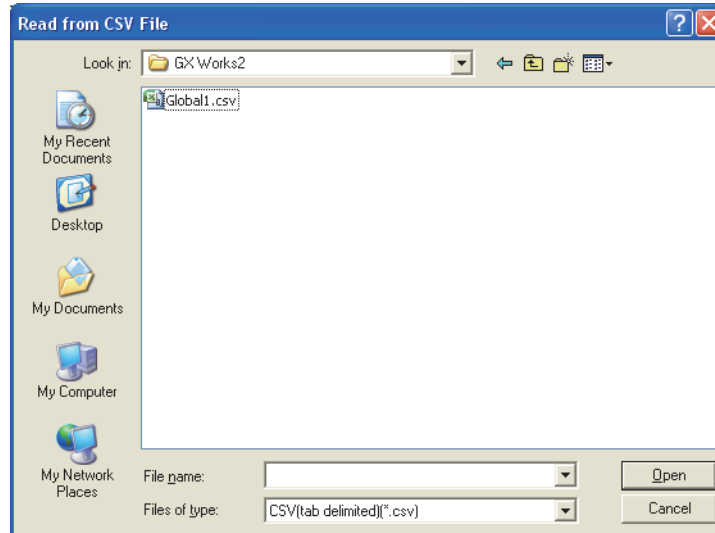

2. Select the file name to be read and click the  button.

The following message is displayed.

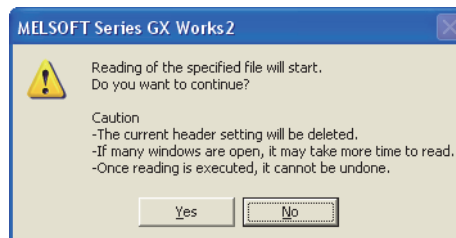

3. Click the  button.

The label setting data is read to the project.

## ■ CSV file format

The title name of Label Setting Editor links with the title name of the CSV file.

- Data of column which coincides in the title name of Label Setting Editor in the CSV file is read to Label Setting Editor.
- Data of column which does not coincide in the title name of Label Setting Editor cannot be read to the CSV file.
- Columns order of the CSV file can be read even if it does not coincide in the columns order of Label Setting Editor.

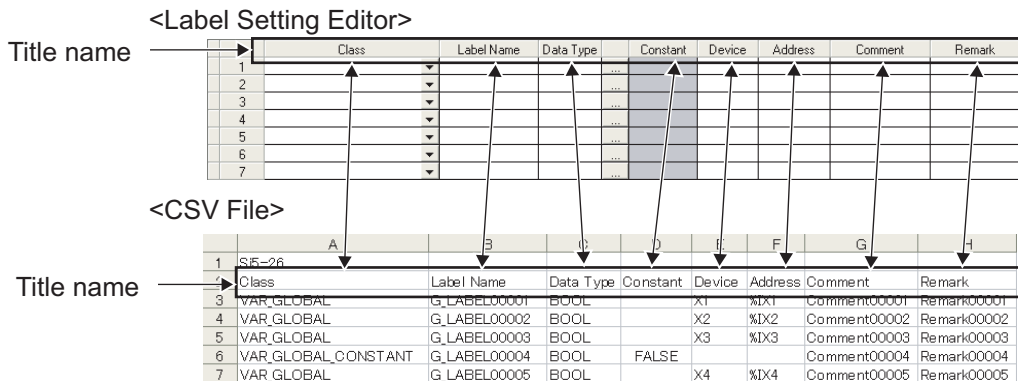

### Restrictions

#### ● When multi-byte characters are used in the label name

Do not use multi-byte characters in a label name when using a CSV file created in Japanese version of GX Works2 in other language version of GX Works2.

When a CSV file which contains multi-byte characters is read in GX Works2 with the language version other than Japanese, the program cannot be compiled properly.



# 6

# COMMON OPERATIONS OF PROGRAM EDITORS

This chapter explains the common operations of program editors used to edit sequence programs.

6.1	Types of Program Editor	6 - 2
6.2	Common Operations of Program Editors	6 - 5

1	OVERVIEW
2	SCREEN CONFIGURATION
3	PROGRAMMING PROCEDURE
4	PROGRAM CONFIGURATIONS
5	SETTING LABELS
6	COMMON OPERATIONS OF PROGRAM EDITORS
7	EDITING ST PROGRAMS
8	EDITING STRUCTURED LADDER/FBD PROGRAMS

## 6.1 Types of Program Editor

Q CPU L CPU FX

This section explains how to edit programs according to the programming language.

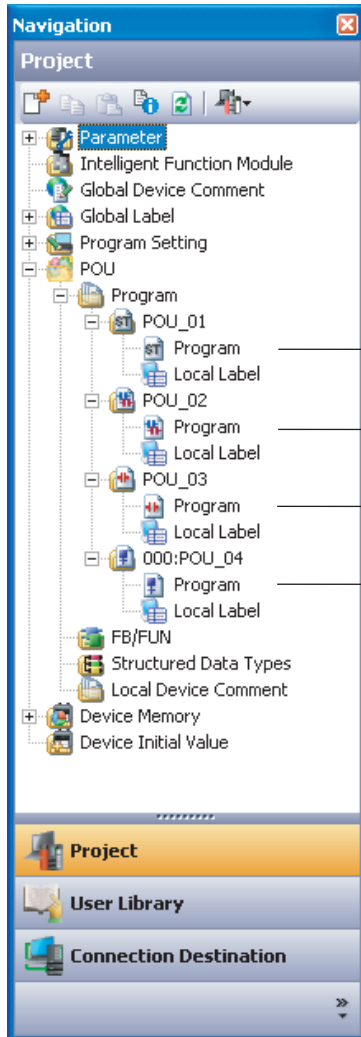

ST editor (☞\*1)

```
POU_01 [PRG] Program [ST]
FOR counter:=0 TO 10 BY 2 DO
IF Var02< 12345 THEN
  Var01 :=Var01 + counter;
ELSIF Var01 >22400 THEN
  Var01 := Var01+Var02;
END_IF;
END_FOR;
```

Structured Ladder/FBD editor (☞\*2)

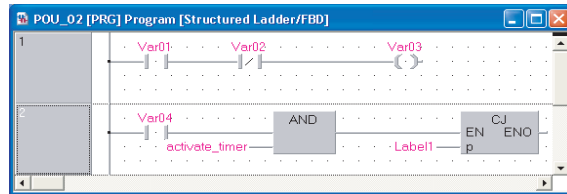

Ladder editor

For the operating method of the ladder editor, refer to the following manual.

☞ GX Works2 Version 1 Operating Manual (Simple Project)

SFC editor

For the operating method of the SFC editor, refer to the following manual.

☞ GX Works2 Version 1 Operating Manual (Simple Project)

\*1 : ☞ Chapter 7

\*2 : ☞ Chapter 8

### Point

#### ● Creating new POU

POUs are created on the Project view. (☞ GX Works2 Version 1 Operating Manual (Common))  
Program data are created paired with a label editor when a new POU is created.

## 6.1.1 Available programming languages

The following table shows the programming languages that can be used for each POU.

○: Available ×: Not available

POU	Programming language			
	Structured Text	Structured Ladder/ FBD	Ladder Diagram*1	Sequential Function Chart*1
Function	○	○	×	×
Function Block	○	○	○	×
Program blocks	○	○	○	○

\*1 : Not supported by FXCPU.

### Point

#### ● Changing programming languages

- Select a programming language when creating a new POU.  
For creating a new data, refer to the following manual.  
 GX Works2 Version 1 Operating Manual (Common)
- The programming language that is selected when creating a program, cannot be changed later.  
To change to another programming language, create a new POU.

1  
OVERVIEW2  
SCREEN  
CONFIGURATION3  
PROGRAMMING  
PROCEDURE4  
PROGRAM  
CONFIGURATIONS5  
SETTING LABELS6  
COMMON  
OPERATIONS OF  
PROGRAM EDITORS7  
EDITING ST  
PROGRAMS8  
EDITING STRUCTURED  
LADDER/FBD  
PROGRAMS

## 6.1.2 Available comment types

The following explains comment types that can be used for each program editor.

### ■ Comments on the ST editor

On the ST editor, comments are enclosed by '(\*' and \*)'.

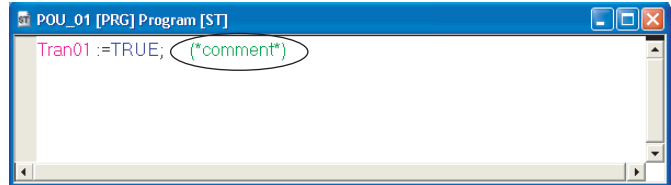

### ■ Comments on the Structured Ladder/FBD editor

On the Structured Ladder/FBD editor, comments can be pasted anywhere in the same manner as elements.

(☞ Section 8.9)

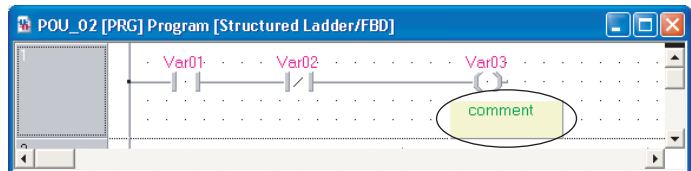

In the Guided mode, comments can be added at the start of a ladder block.

(☞ Section 8.10.9)

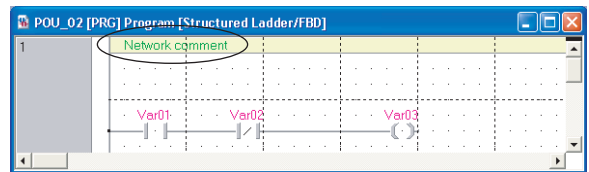

### ■ Label comments

Label comments and remarks set at label setting can be displayed on tooltips.

(☞ Section 6.2.8)

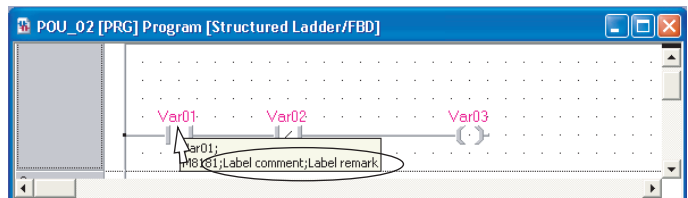

### ■ Device comments

Global device comments or local device comments can be displayed on tooltips.

(☞ Section 6.2.8)

For details of device comments, refer to the following manual.

☞ GX Works2 Version 1 Operating Manual (Common)

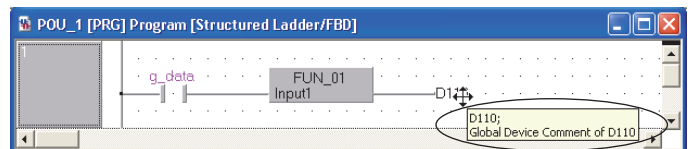

## 6.2 Common Operations of Program Editors

Q CPU L CPU FX

This section explains the common operations of program editors (ST editor and Structured Ladder/FBD editor).

The operating method when using a Structured Ladder/FBD editor is explained in this section.

### 6.2.1 Using POUs (Element Selection window)

Select POUs such as functions and function blocks from the Element Selection window and utilize them to the program.

#### Screen display

Select [View] ⇒ [Docking Window] ⇒ [Element Selection] (  ).

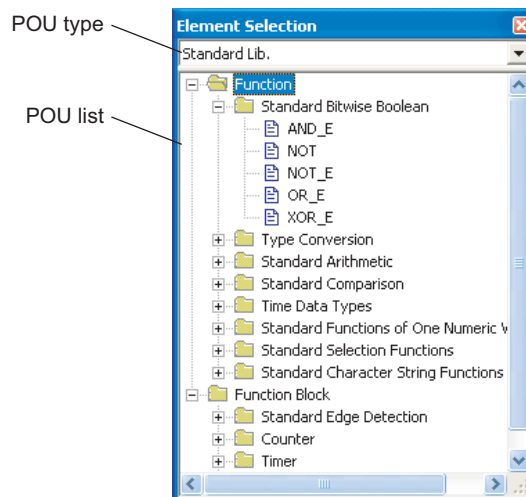

#### Display contents

Item	Description
POU type	Display POUs in categories.
All Parts	Display functions/function blocks and operators.
Application Instruction	Display functions/function blocks of application functions.
(Instructions)* <sup>1</sup>	Display common instructions, application instructions, and special instructions.
User library (User library name)	Display functions defined in the user library.
Project	Display functions/function blocks defined in FB/FUN.
Operator	Display operators.
POU list	Display POUs of the type selected for 'POU type'.
Function* <sup>2</sup>	Display functions.
Function Block* <sup>2</sup>	Display function blocks.
Operator* <sup>2</sup>	Display operators.

\*1 : For FXCPU, basic instructions and application instructions are displayed.

\*2 : For details of functions/function blocks/operators, refer to the following manual.  
(  MELSEC-Q/L/F Structured Programming Manual (Fundamentals) )

### Operating procedure

1. Select a POU to be used from the 'POU list'.
2. Drag & drop the selected POU to the program editor.

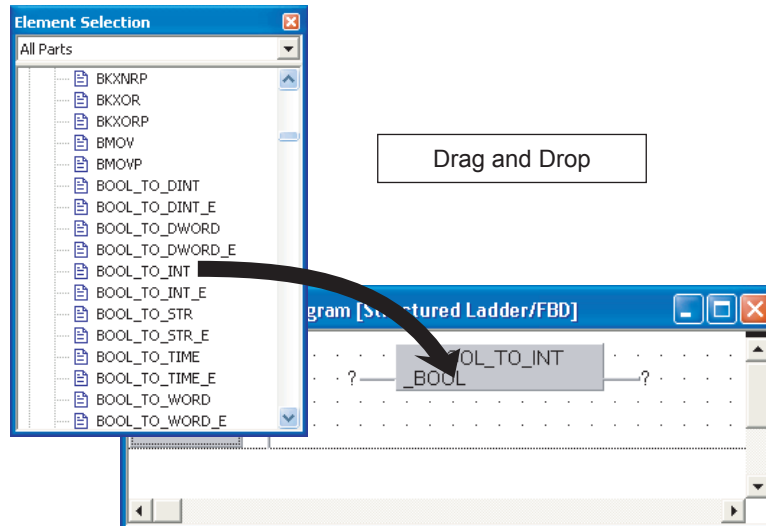

### Point

#### ● Dragging and dropping POUs from the Element Selection window

When utilizing POUs from the 'POU list', activate the target program editor before performing the drag-and-drop operation.

When the programming languages of the POU to be utilized and the target program editor are different, a POU cannot be dragged and dropped while changing the program editor.

### ■ Searching for a POU name by its initial letter

Search for a particular item among those displayed on the POU list tree by its initial letter.

### Operating procedure

- In the POU list field, enter the initial letter of the POU to be searched for.

The cursor moves to the entered initial letter of the POU.

If there is no POU with the entered initial letter, the selection status does not change.

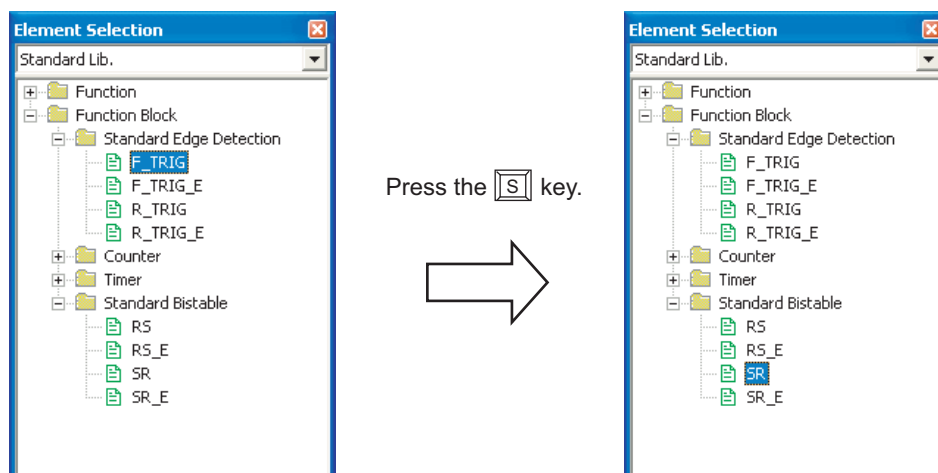



## ■ Displaying label settings

Display a label setting editor by right-clicking a function or function block.

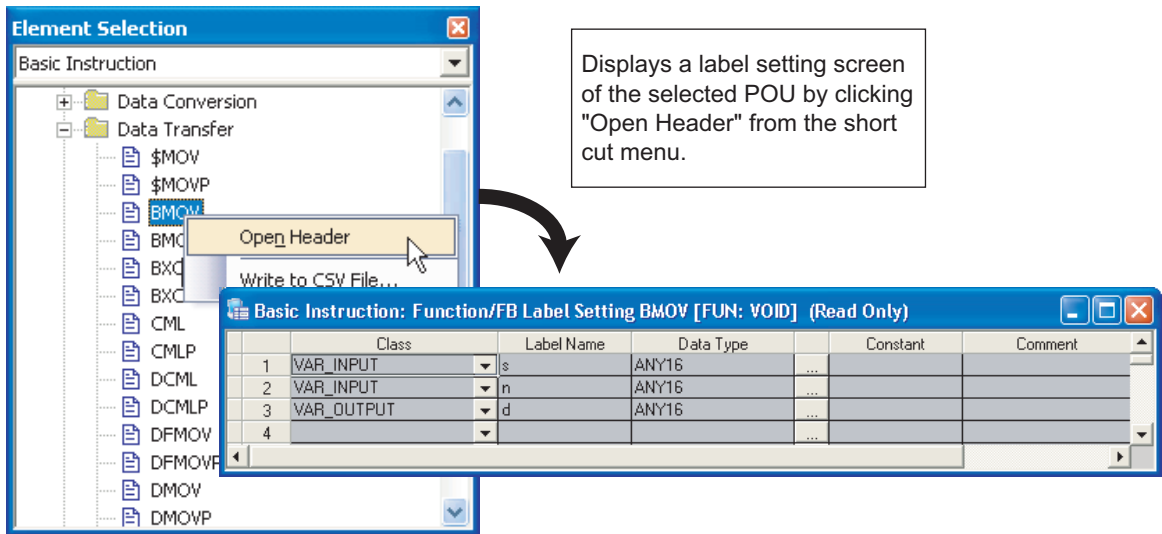

### Point

#### ● Operators

Since label settings are not available for operators, short cut menu is not displayed.

1 OVERVIEW

2 SCREEN CONFIGURATION

3 PROGRAMMING PROCEDURE

4 PROGRAM CONFIGURATIONS

5 SETTING LABELS

6 COMMON OPERATIONS OF PROGRAM EDITORS

7 EDITING ST PROGRAMS

8 EDITING STRUCTURED LADDER/FBD PROGRAMS

## 6.2.2 Using labels in the program

Enter preset labels to program editor. A new label can also be registered.

### Screen display

Select [Edit] ⇒ [List Operands] (  ).

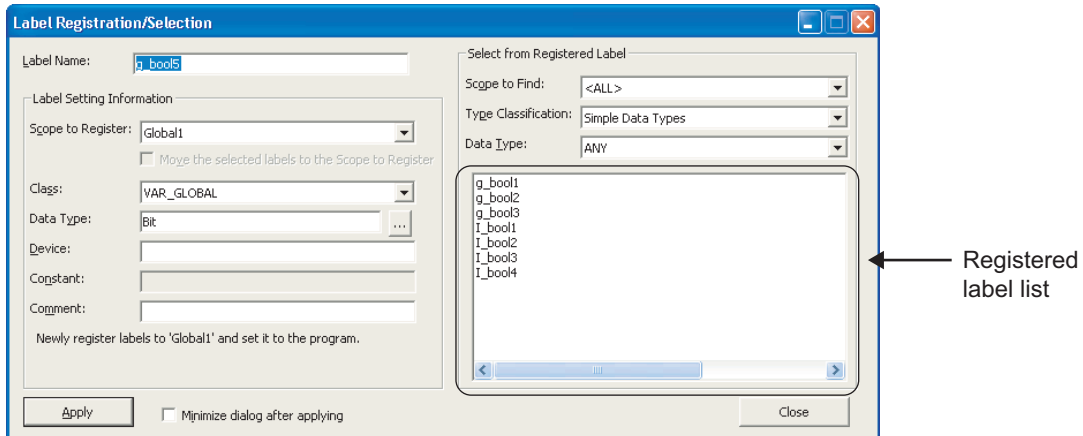

### Point



#### ● Display setting for Label Registration/Selection screen

For a Structured Ladder/FBD program, the Label Registration/Selection screen can be displayed when inserting an undefined label by setting the option below.

Select "Declare new label name" under [Tool] ⇒ [Options] ⇒ "Program Editor" ⇒ "Structured Ladder/FBD" ⇒ "Label".

### ■ Entering registered labels

Select and enter the registered labels on the Label Registration/Selection screen.

Register labels with label setting editor (  Chapter 5) or on the Label Registration/Selection screen (  ■ Registering new labels).

### Operating procedure

1. Select the argument to which a label is entered on a program editor.



2. Select [Edit] ⇒ [List Operands] (  ).

The Label Registration/Selection screen is displayed.

### 3. Set the items on the screen.

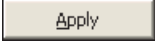
Item	Description
Select from Registered Label	-
Scope to Find	Select a label setting editor's name of the search destination.
Type Classification	Select a type classification of data type. (☞ Section 5.5.3)
Data Type	Select a data type.
Registered label list	<p>Display a list of labels existing in the label setting editor of the search destination. Select a label to be entered.</p> <p>When "Function Blocks" or "Structured Data Types" is selected for "Type Classification", labels are displayed by double-clicking "+" indicated in front of the function block name or structure label name.</p> 
Minimize dialog after applying	After clicking the  button, select this to minimize the <u>Label Registration/Selection</u> screen.

### 4. Click the button.

The selected label is applied to the program editor.

## ■ Registering new labels

Select and enter the new labels on the Label Registration/Selection screen.

### Operating procedure

#### 1. Select the argument to which a label is entered on a program editor.



#### 2. Select [Edit] ⇒ [List Operands] ( ).

The Label Registration/Selection screen is displayed.

1

OVERVIEW

2

SCREEN CONFIGURATION

3

PROGRAMMING PROCEDURE

4

PROGRAM CONFIGURATIONS

5

SETTING LABELS

6

COMMON OPERATIONS OF PROGRAM EDITORS







7

EDITING ST PROGRAMS

8

EDITING STRUCTURED LADDER/FBD PROGRAMS

### 3. Set the items on the screen.

Item	Description
Label Name	Enter a label name.
Label Setting Information	-
Scope to Register	Select a label setting editor's name of registering destination.
Class	Select a class name of label from the list displayed by clicking  . (  Section 5.5.1)
Data Type	Set a data type from the <u>Data Type Selection</u> screen displayed by clicking  . (  Section 5.5.3) It can also be entered directly.
Device	Set a device to be assigned to the label when "VAR_GLOBAL" is selected for "Class". • When the "Device" column is blank, a device is automatically assigned.
Constant	Enter a constant value when "VAR_GLOBAL_CONSTANT" or "VAR_CONSTANT" is selected for "Class", and simple type is selected for Data Type".
Comment	Enter a label comment. Comments can be displayed on the program editor by switching display/hide of comments. (  Section 8.7.4) A new line cannot be inserted. Edit a comment with a label setting editor to insert a new line.
Minimize dialog after applying	After clicking the  button, select this to minimize the <u>Label Registration/Selection</u> screen.





### 4. Click the button.

The label is registered and applied to the program editor.

## ■ Changing registered label settings

Change the settings of registered labels on the Label Registration/Selection screen.  
Label setting editor and data type of registered label can be changed.

### Operating procedure

- Select [Edit] ⇒ [List Operands] (  ).**  
The Label Registration/Selection screen is displayed.
- Select the label from "Registered Label List".**  
For items of "Select from Registered Label", refer to " ■ Registering new labels".
- Change the settings on "Label Setting Information".**  
For items of "Label Setting Information", refer to " ■ Registering new labels"
- For changing the label setting editor, select "Move the selected labels to the Scope to Register".**
- Click the  button.**  
The label settings are changed.

## 6.2.3 Undo and redo

Undo and redo the previous editing status.

### ■ Undo

#### Operating procedure

- Select [Edit] ⇒ [Undo] (  ) after editing the ladder program.  
The previous editing status is restored.

### ■ Redo

#### Operating procedure

- Select [Edit] ⇒ [Redo] (  ) after performing [Undo].  
The operation deleted by clicking the [Undo] button is restored.

## 6.2.4 Changing display size of editing screen

Change the display size of editing screen.

Display size of all ST editors and Structured Ladder/FBD editors is changed.

### ■ Changing display size by specifying a magnification ratio

#### Screen display

Select [View] ⇒ [Zoom] ⇒ [Set Zoom Factor].

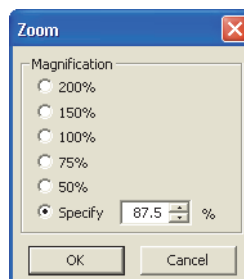



#### Operating procedure

- Set the items on the screen.

Item	Description
200%, 150%, 100%, 75%, 50%	Change the display size of editing screen with a selected magnification.
Specify	Set a magnification specified by every 12.5%.

## ■ Changing display size

### Operating procedure

- Select [View] ⇒ [Zoom] ⇒ [Increase Zoom] (  )/[Decrease Zoom] (  ).  
The editing screen is zoomed in/out in increments of 12.5%.

## 6.2.5 Splitting editing screen

Split the editing screen one above the other.

### Operating procedure

- Drag the split bar on the scroll bar of the editing screen.

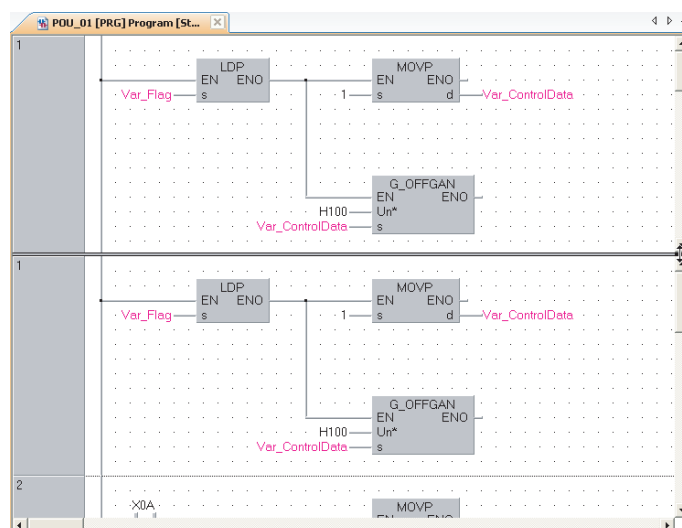
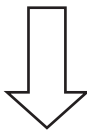
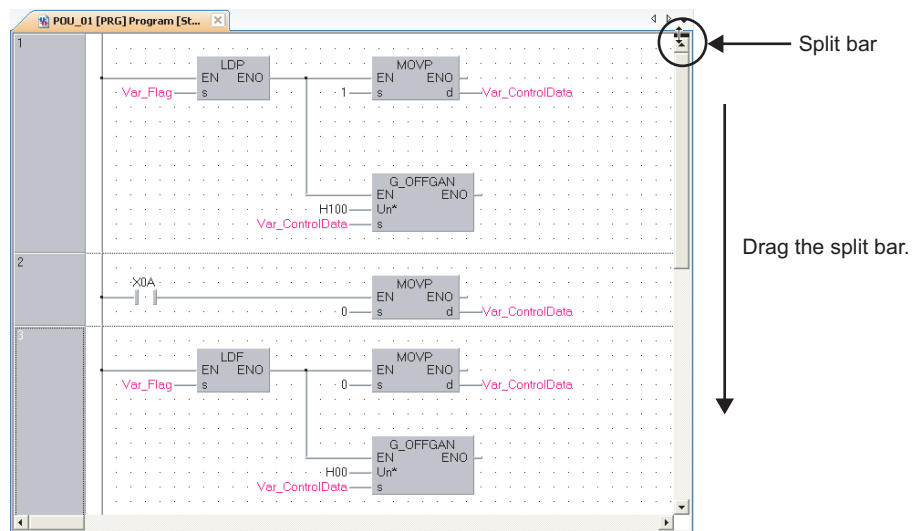

## 6.2.6 Opening local label setting screen of program editor being edited

Display the Local Label Setting screen of the program editor being edited.

### Operating procedure

- Select [View] ⇒ [Open Header].

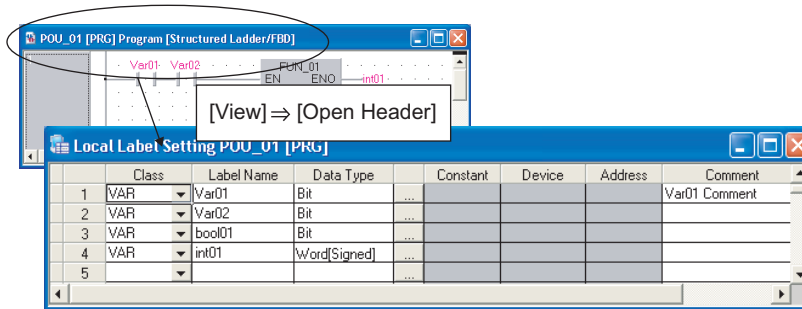

## 6.2.7 Displaying compilation result in list format

Display a compiled program in a list format.

A selected ladder block for Structured Ladder/FBD or a whole editor currently opened for ST is the compilation target.

### Operating procedure

1. For Structured Ladder/FBD, select a ladder block.
2. Select [View] ⇒ [Display Compile Result].

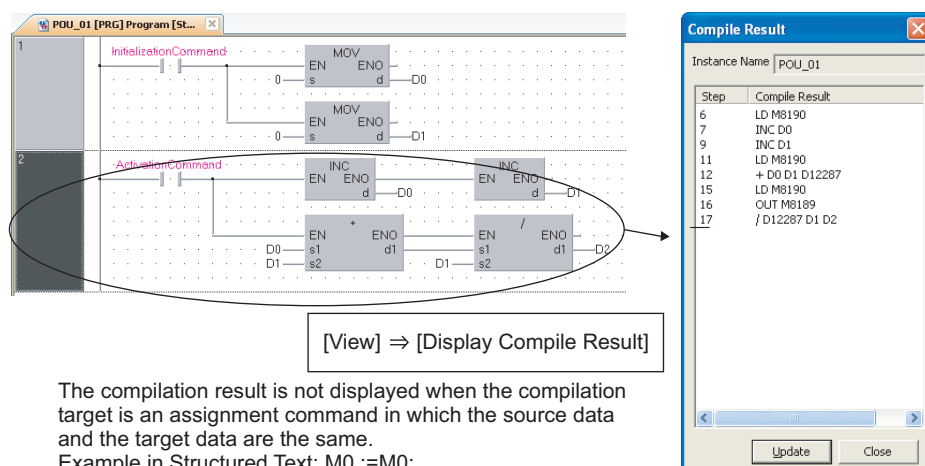

The compilation result is not displayed when the compilation target is an assignment command in which the source data and the target data are the same.  
Example in Structured Text: M0 :=M0;

### Point

#### ● Considerations of FXCPU

For FXCPU, when a block password with the validated setting for "Read-protect the execution program" exists, the compilation result cannot be displayed.

## 6.2.8 Setting display content of tooltip

Content defined on the label setting editor is displayed as tooltip by placing the cursor on a label name on the program editor.

Content excluding label names displayed on the tooltips can be set by the following operation.

### Operating procedure

1. Select [Tool] ⇒ [Options] ⇒ "Program Editor" ⇒ "Structured Ladder/FBD/ST" ⇒ "Tool Hint".
2. Set the following items:

Item	Description	Example	
Tool Hint Display Items	Monitored Value	Display a monitoring result. When the labels are used for array element, or when the elements are not specified for array or structure, the monitoring values are not displayed.	(Displayed only during monitoring)
	Class	Display a label class.	VAR_GLOBAL
	Device	Display a device or device assigned to the label in the device format.	X1
	Address	Display a device assigned to the label in the address format.	%IX1
	Device comment	Display a device comment. Device comments of devices assigned to labels are not displayed.	X1 comment
	Data Type	Display a data type of the label.	Bit
	Constant Value	Display a constant value of the label.	FALSE
	Label comment	Display label comments.	GLOBAL1 comment
	Remark	Display a remark of the label. (global label only)	GLOBAL1 remark
Tool Hint Display Format	Single Line	Display tooltips in a single line.	
	Multi Line	Display tooltips in multiple lines.	

<Single line>

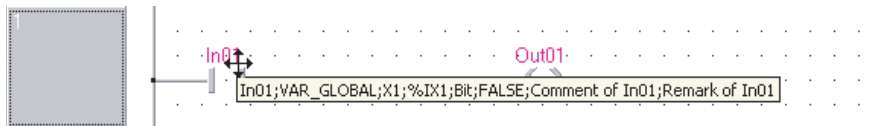

<Multiple lines>

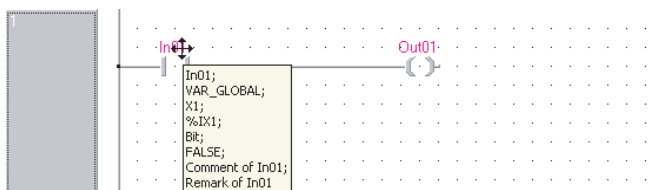



## 6.2.9 Opening label setting and program screens for selected POU

Display label settings or a program of the function or function block selected on the program editor.

### ■ Displaying a label setting editor

#### Operation

- Select [View] ⇒ [Zoom Header/Body] ⇒ [Header].

### ■ Displaying a program editor

#### Operation

- Select [View] ⇒ [Zoom Header/Body] ⇒ [Body].

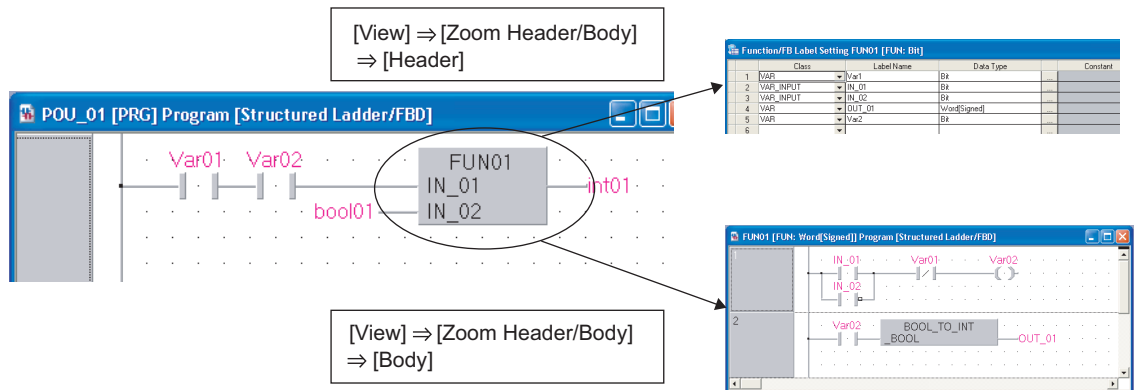

#### Point

#### ● Displaying by double-clicking the function or function block

For a Structured Ladder/FBD program, a label editor or program editor can be opened by double-clicking POU.

Select [Tool] ⇒ [Options] ⇒ "Program Editor" ⇒ "Structured Ladder/FBD" ⇒ "FB/FUN" and set "Double clicking opens header" or "Double clicking opens body".

1  
OVERVIEW2  
SCREEN CONFIGURATION3  
PROGRAMMING PROCEDURE4  
PROGRAM CONFIGURATIONS5  
SETTING LABELS6  
COMMON OPERATIONS OF PROGRAM EDITORS7  
EDITING ST PROGRAMS8  
EDITING STRUCTURED LADDER/FBD PROGRAMS





# 7

# EDITING ST PROGRAMS

This chapter explains the functions of ST editor to edit ST programs.

7.1 ST Editor

7 - 2

1	OVERVIEW
2	SCREEN CONFIGURATION
3	PROGRAMMING PROCEDURE
4	PROGRAM CONFIGURATIONS
5	SETTING LABELS
6	COMMON OPERATIONS OF PROGRAM EDITORS
7	EDITING ST PROGRAMS
8	EDITING STRUCTURED LADDER/FBD PROGRAMS

## 7.1 ST Editor

Q CPU L CPU FX

This section explains how to edit programs on the ST editor.

The ST editor is a language editor in text format for creating programs in Structured Text.

The operating method is the same as that of general text editor. Spaces, tabs, and line feeds can be entered between keywords and variable names of the ST control syntax.

### Screen display

Select Project view ⇒ "POU" ⇒ "Program" ⇒ "(program)" ⇒ "Program".

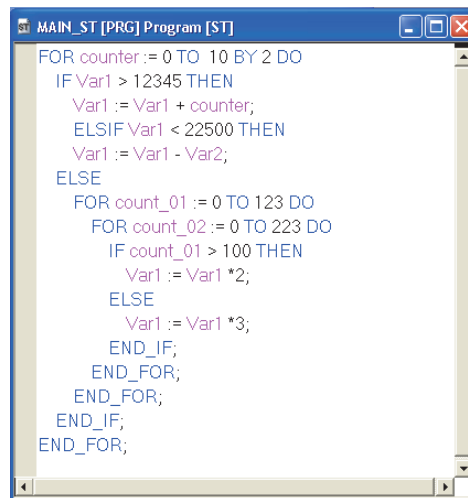

```

MAIN_ST [PRG] Program [ST]
FOR counter := 0 TO 10 BY 2 DO
  IF Var1 > 12345 THEN
    Var1 := Var1 + counter;
  ELSIF Var1 < 22500 THEN
    Var1 := Var1 - Var2;
  ELSE
    FOR count_01 := 0 TO 123 DO
      FOR count_02 := 0 TO 223 DO
        IF count_01 > 100 THEN
          Var1 := Var1 * 2;
        ELSE
          Var1 := Var1 * 3;
        END_IF;
      END_FOR;
    END_FOR;
  END_IF;
END_FOR;
  
```

### Point

#### ● Display colors

On the ST editor, the following display colors can be specified by selecting [View] ⇒ [Color and Font].

The colors in the parentheses indicate the default colors.

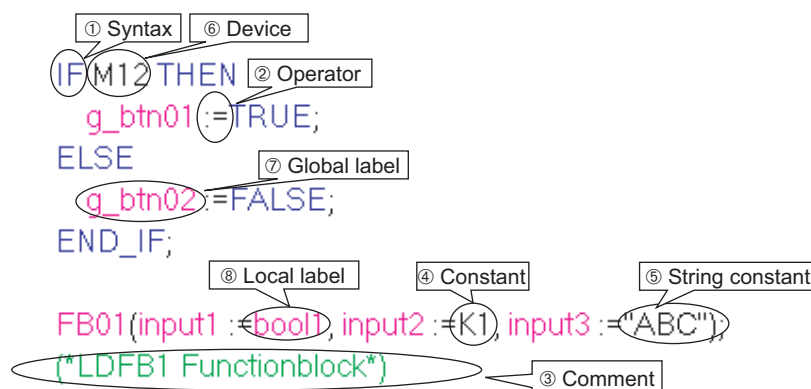

- ① Syntax (Blue)
- ② Operator (Black)
- ③ Comment (Dark green)
- ④ Constant (Black)
- ⑤ String constant (Black)
- ⑥ Device (Black)
- ⑦ Global label (Magenta)
- ⑧ Local label (Magenta)

For details, refer to the following manual.

☞ GX Works2 Version 1 Operating Manual (Common)

## 7.1.1 Writing ST programs

Write an ST program.

For functions/instructions used for ST program, refer to the structured programming manuals.

### Operating procedure

- **Write a program in the text format using a keyboard.**

The colors of defined labels, devices, syntax, operators, constants, string constants, and comments change when they are entered.

Syntax entered in lower-case characters are automatically changed to upper-case characters.

```
MAIN_ST [PRG] Program [S... x]
FOR counter :=0 TO 10 BY 2 DO
```

### Point

- **Options of instructions/labels displayed while typing a label**

Global labels and local labels of corresponding POU are displayed.

Select [Tool] ⇒ [Options] ⇒ "Program Editor" ⇒ "ST" ⇒ "Instruction/label name prediction". (☞ Section 14.2)

- **Entering assignment operators**

Press the **Ctrl** + **Shift** + **=** keys to enter an assignment operator (:=).

## 7.1.2 Automatic indentation

Insert a tab as the indentation at the head of a new line automatically when a line feed is inserted during program editing.

The indentation can be set in the option setting.

### Operating procedure

1. Select [Tool] ⇒ [Options] ⇒ "Program Editor" ⇒ "ST".
2. Select "Auto Indentation".
3. Enter the ST control statement to the ST editor (such as a FOR statement).

When a line feed is inserted, the next line is indented based on the content of the statement.

```
MAIN_ST [PRG] Program [ST]
FOR counter :=0 TO 10 BY 2 DO
  |
```

```
MAIN_ST [PRG] Program [ST]
FOR counter :=0 TO 10 BY 2 DO
  |
```

### 7.1.3 Setting tab length

---

Set a tab length in the option setting.

#### **Operating procedure**

1. Select [Tool] ⇒ [Options] ⇒ "Program Editor" ⇒ "ST".
2. Set "Tabulator Length in ST".

## 7.1.4 Using templates

Insert templates correspond to the instructions/functions/control syntax on the ST editor.

A template of argument is inserted when an instruction or function is entered from the Element Selection window with the drag-and-drop operation.

A template is an argument data type defined for each instruction/function or a format of control syntax. For details of data types and formats displayed in the templates, refer to the following manual.

 MELSEC-Q/L/F Structured Programming Manual (Fundamentals)

### Operating procedure

1. Move the cursor to the instruction/function/control syntax entered to the ST editor.
2. Select [Edit] ⇒ [Display Template] (  ).

A template is inserted.

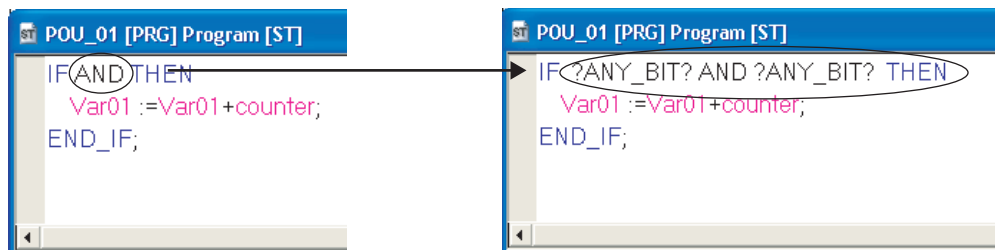

3. Enter variables according to the inserted template.

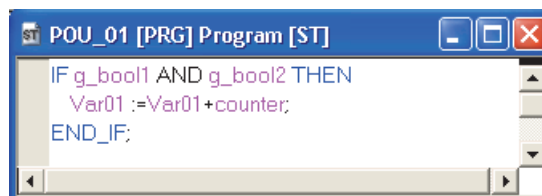

Delete the data type name enclosed by "?", and enter a label name or device that is equivalent to the data type.



**Point****● Inserting templates**

A template can also be inserted by right-clicking the instruction/function/control syntax entered to the ST editor and selecting [Display Template] (  ) from the shortcut menu.

**● Editing arguments**

Select [Edit] ⇒ [Mark Template (Left)] (  )/[Mark Template (Right)] (  ), or press **Ctrl** + **Alt** + **←** / **→** keys to set an argument of the template in the selected status one by one.

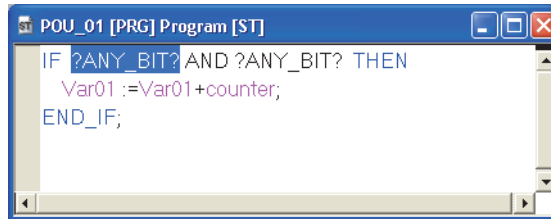
**● Considerations of argument when calling function blocks**

The output argument VAR\_OUTPUT is not displayed on the template when "Allow VAR\_OUTPUT at FB call (ST)" under [Tool] ⇒ [Options] ⇒ "Compile" ⇒ "Structured Ladder/FBD/ST"\*1 ⇒ "Compile Condition1" is not selected.

\*1 : For Simple project (with labels), select the following.  
[Tool] ⇒ [Options] ⇒ "Compile" ⇒ "ST"





# 8 EDITING STRUCTURED LADDER/FBD PROGRAMS

This chapter explains the functions of program editor to edit Structured Ladder/FBD programs.

8.1	Creating Ladder/FBD Programs	8 - 2
8.2	Editing in Select Mode	8 - 4
8.3	Drawing Lines	8 - 7
8.4	Operating Elements	8 - 11
8.5	Changing Type of Contact and Coil	8 - 15
8.6	Operating Functions and Function Blocks	8 - 18
8.7	Changing Display Format of Variables	8 - 21
8.8	Editing Ladder Blocks	8 - 27
8.9	Editing Comments	8 - 34
8.10	Editing in Guided Mode	8 - 36
8.11	Checking Wrapping Position for Printing	8 - 41

# 8.1 Creating Ladder/FBD Programs

Q CPU L CPU FX

This section explains how to create ladder programs and functions for creating ladder programs on the Structured Ladder/FBD editor.

The Structured Ladder/FBD editor is a language editor in graphic format for creating programs in Structured Ladder/FBD.

Elements such as contacts, coils, and functions/function blocks are used to create Structured Ladder/FBD programs. Each element is connected with a line.

The suitable editing mode can be selected according to the program entry method and editing target. (☞ Section 8.1.1)

## Screen display

Select Project view ⇒ "POU" ⇒ "Program" ⇒ "(program)" ⇒ "Program".

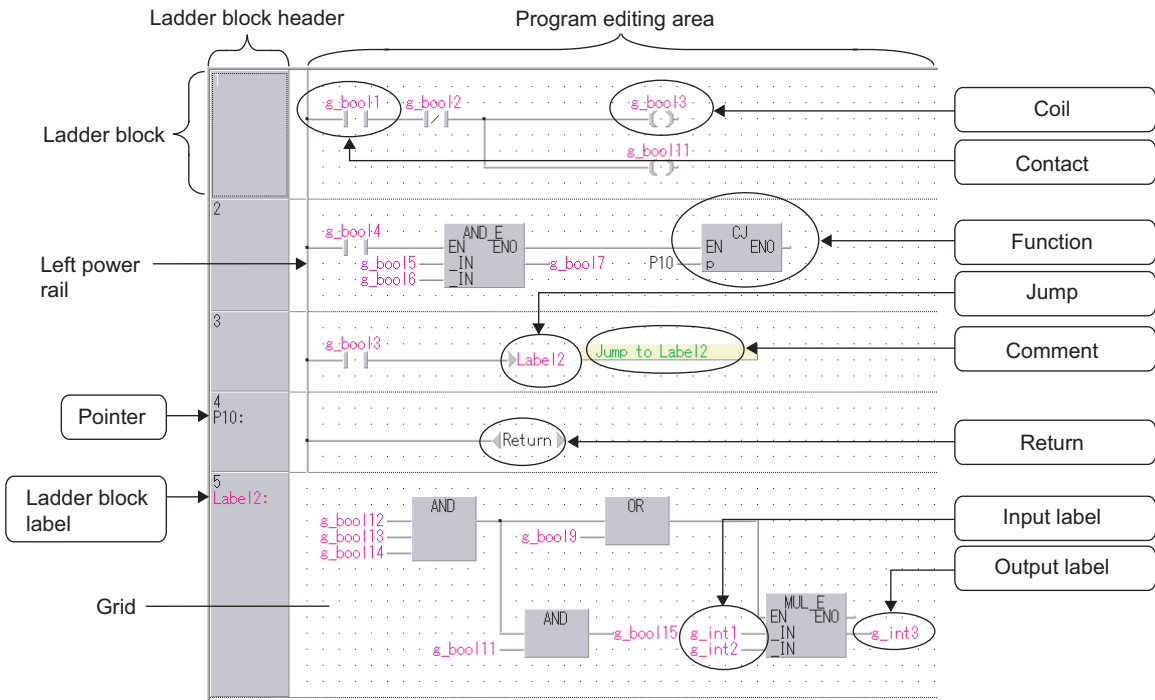

## Display contents

Name	Description	Reference
Ladder block	A unit for creating a program A ladder block consists of a ladder block header and a program editing area.	Section 8.8
Ladder block header	Display information such as a title set for each ladder block, and a label name of the jump target.	Section 8.8.4
Program editing area	An area for creating a program. Elements can be placed on the grid area.	Section 8.1
Left power rail	A start position of the Structured Ladder program. For FBD, the display of left power rail can be switched to hide.	Section 8.8.7
Grid	Indicate specific positions of tab stop and start/end positions of lines.	Section 8.8.8









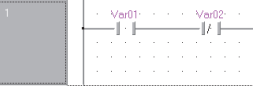

## 8.1.1 Selecting editing modes

Select a program editing mode. The following table shows the selectable modes.

Mode	Description	Reference
Select Mode	Place elements such as contacts and coils in a ladder block. Connect elements with a line. This mode is used for editing programs mainly with the mouse.	Section 8.2
Interconnect mode	Connect placed elements with a line.	Section 8.3.2
Guided mode	Place elements such as contacts, coils, and instructions within the grid frames. This mode is used for editing programs mainly with the keyboard.	Section 8.10

### ■ Mouse cursor and grid

The following table shows different appearances of the mouse cursor and grid according to the mode. For connecting lines automatically, refer to Section 8.3.3.

Mode	Menu and toolbar	Auto connect	Mouse cursor	Grid display
Select mode	[Edit] ⇒ [Select Mode] 	OFF		
		ON		
Interconnect mode	[Edit] ⇒ [Interconnect Mode] 	OFF		
		ON		
Guided mode	[Edit] ⇒ [Guided Mode] ⇒ [Guided Editing] 	OFF		

1 OVERVIEW

2 SCREEN CONFIGURATION

3 PROGRAMMING PROCEDURE

4 PROGRAM CONFIGURATIONS

5 SETTING LABELS

6 COMMON OPERATIONS OF PROGRAM EDITORS

7 EDITING ST PROGRAMS

8 EDITING STRUCTURED LADDER/FBD PROGRAMS

## 8.2 Editing in Select Mode

Q CPU L CPU FX

This section explains how to enter instructions.

### 8.2.1 Entering elements

Enter elements such as contacts, coils, and application instructions.

Element	Toolbar	Shortcut key
Open contact*1		[1]
Closed contact*1		[2]
Coil*1		[7]
Jump		[Ctrl] + [J]
Return		[Ctrl] + [R]
Open contact branch*1		[3]
Closed contact branch*1		[4]
Input label		[9]
Output label		[0]
Horizontal line		[6]
Vertical line		[5]
Rising pulse*1, *2		-
Falling pulse*1, *2		-
Rising pulse close*1, *3		-
Falling pulse close*1, *3		-
Comment		[Ctrl] + [M]

\*1: These items cannot be used for FBD.

\*2: Not supported by FX0, FX0S, FX0N, FXU, FX2C.

\*3: Supported by Universal model QCPU/LCPU.

#### Operating procedure

**1. Select [Edit] ⇒ [Ladder Symbol] ⇒ [(element)].**

The shape of the mouse cursor changes according to the selected element.

**2. Click the position where the element is entered in the program editing area.**

The selected element is entered.

## 8.2.2 Entering instructions

Enter an instruction in the Select mode.

### Operating procedure

1. Select [Edit] ⇒ [Input Instruction] (  ).

The Input Instruction screen is displayed.

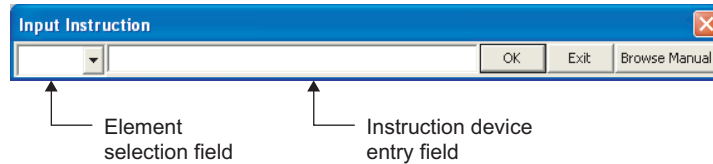

The following table shows the display contents of the screen.

Name	Description
Element selection field	Select an element. Clicking the  button displays the list of elements.
Instruction device entry field	Enter an instruction and/or a device.

2. Enter an instruction and device, and click the  button.

The shape of the cursor changes according to the selected instruction.

3. Click the desired position.

The instruction is entered at the cursor position.

### ■ Changing instruction

Change entered operator, function, or function block.

### Operating procedure

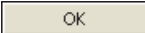
1. Select an operator, function, or function block to be changed.
2. Enter the instruction with the operator, function, or function block being selected, and click the  button.

The operator, function, or function block is changed.

After changing the instruction, adjust the arguments of the instruction if necessary.

**Point****● Entering POUs**

Operators, functions, and function blocks can also be selected from the Element Selection window. (☞ Section 6.2.1)

- When nothing is entered in the element selection field, 'instruction + space + device/label' can be entered. (For example: Id X0) However, when an instruction exists as an element; such as JMP and RET, is entered, it is entered as an element. For entering in functional description, select "FB" on the element selection field, and enter an instruction such as JMP.

**● Entering unregistered labels**

By setting the option, a new label setting can be added on the Label Registration/Selection screen when an unregistered label is entered.

Select "Declare new label name" under [Tool] ⇒ [Options] ⇒ "Program Editor" ⇒ "Structured Ladder/FBD" ⇒ "Label". (☞ Section 14.2)

**● Browse Manual button**

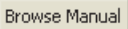
A detail of the instruction can be displayed by clicking the  button on the Input Instruction screen. (☞ GX Works2 Version 1 Operating Manual (Common))

## 8.3 Drawing Lines

Q CPU L CPU FX

This section explains how to create lines in a program.

### 8.3.1 Connecting lines automatically when entering elements

When entering elements of contacts/coils/jump/return in the Select mode, the line can be connected automatically.

#### Operating procedure

**1. Select [Edit] ⇒ [Ladder Symbol] ⇒ [(element to be entered)].**

A graphical image of the selected element is appended to the mouse cursor.

If a line can be connected to the left-hand horizontal direction, a line is displayed to the left-hand direction.



**2. Click the position where the element is entered.**

If a line can be connected to the left-hand horizontal direction, the following message is displayed.

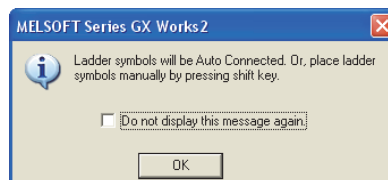

**3. Click the  button.**

The selected element is entered and the line is connected automatically to the left-hand horizontal direction.



#### Point

● **Entering position of elements**

When entering an element, dragging an element moves the entering position of the element.

This function is useful when creating a ladder in parallel as shown below.

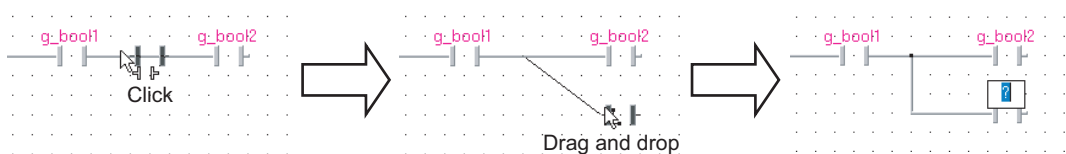

### 8.3.2 Connecting elements with lines

Connect elements with a line.

#### Operating procedure

1. Select [Edit] ⇒ [Select Mode] (  )/[Interconnect Mode] (  ).

For the Interconnect mode, the cursor changes to  .

2. For the Select mode, click the start position of the line.

The cursor changes to  .

3. Drag the line from the start position to the end position.

A line is drawn in a vertical or horizontal straight line.

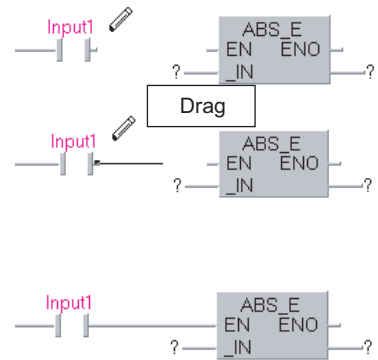

### 8.3.3 Connecting lines automatically

Connect lines automatically by specifying the start and end points.

#### Operating procedure

1. Select [Edit] ⇒ [Auto Connect] (  ).

For the Interconnect mode, the cursor changes from  to



2. Click the start position.

For the Select mode, the cursor changes to  .

3. Click the end position.

The line is automatically routed.

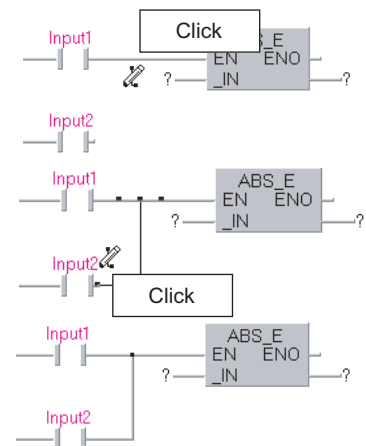



### 8.3.4 Overwriting input/output variable with lines

Overwrite an input/output variable of a function or function block with a line.

#### Operating procedure

1. Select [Tool] ⇒ [Options] ⇒ "Program Editor" ⇒ "Structured Ladder/FBD" ⇒ "FB/FUN".
2. Select "Pin overwrites".
3. Select [Edit] ⇒ [Auto Connect].
4. Draw a line over the input or output variable.

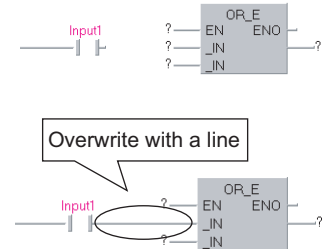

The existing input/output variable is automatically overwritten with the line.

### 8.3.5 Rearranging lines automatically

Rearrange and redraw a line when the Auto connect function is activated. This function is enabled only when the Select mode is selected.

#### Operating procedure

1. Select the line to be rearranged.
2. Select [Edit] ⇒ [Recalculate Line].

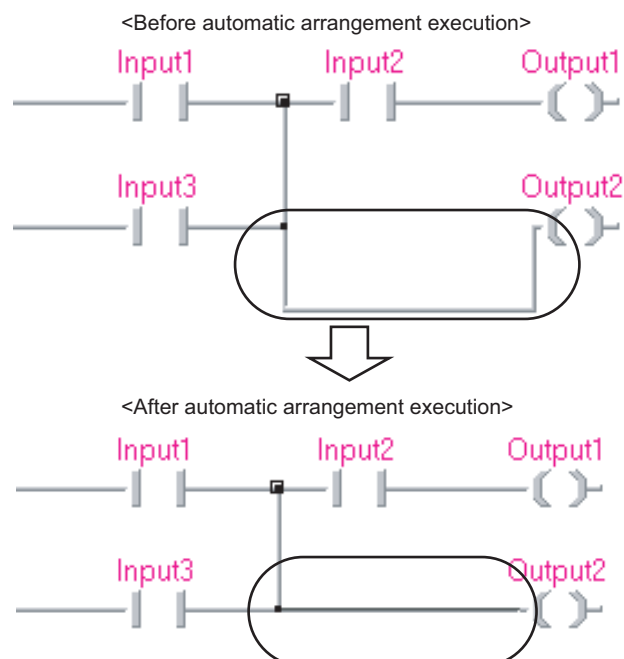
1  
OVERVIEW2  
SCREEN  
CONFIGURATION3  
PROGRAMMING  
PROCEDURE4  
PROGRAM  
CONFIGURATIONS5  
SETTING LABELS6  
COMMON  
OPERATIONS OF  
PROGRAM EDITORS7  
EDITING ST  
PROGRAMS8  
EDITING STRUCTURED  
LADDER/FBD  
PROGRAMS

## 8.3.6 Inserting and deleting rows and columns

Insert and delete rows and columns.

### ■ Inserting rows and columns

Insert a row or a column.

#### Operating procedure

1. Select [Edit] ⇒ [Insert Row] (  )/[Insert Column] (  ).

The cursor changes  to  .

2. Click the position where a row or column is inserted.

A row or column is inserted by each click.

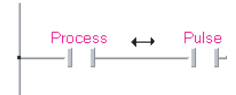

Inserts a column by each click.

### ■ Deleting rows and columns

Delete a row or a column.

#### Operating procedure

1. Select [Edit] ⇒ [Insert Row] (  )/[Insert Column] (  ).

The cursor changes  to  .

2. Hold down the  key and click the position where a row or column is deleted.

A row or column is deleted by each click.

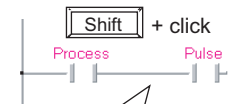

Deletes a column by each click.

## 8.4 Operating Elements



Q CPU L CPU FX

This section explains how to operate elements such as contacts and coils in the Select mode.

### 8.4.1 Moving elements

Disable the Auto connect function and move an element.

#### Operating procedure

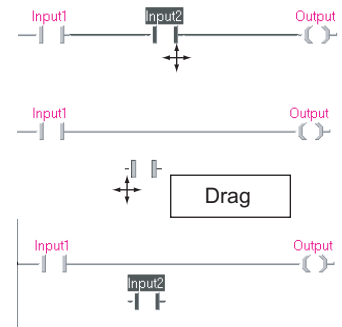

1. Select [Edit] ⇒ [Select Mode] (  ).  
The cursor changes to .
2. Click the element.
3. Drag it to the desired position.



### 8.4.2 Moving elements with lines connected

Enable the Auto connect function and move an element with the lines connected.

#### Operating procedure

1. Select [Edit] ⇒ [Auto Connect].  
The cursor changes from  to .
2. Click the element.
3. Drag it to the desired position.  
The element moves with the lines connected.

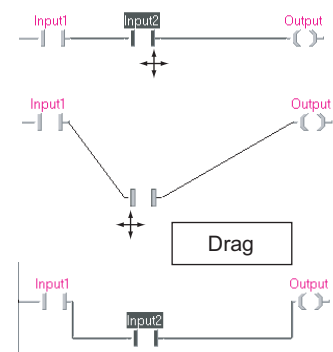
1  
OVERVIEW2  
SCREEN  
CONFIGURATION3  
PROGRAMMING  
PROCEDURE4  
PROGRAM  
CONFIGURATIONS5  
SETTING LABELS6  
COMMON  
OPERATIONS OF  
PROGRAM EDITORS7  
EDITING ST  
PROGRAMS8  
EDITING/STRUCTURED  
LADDER/FBD  
PROGRAMS

## Point

### ● Bend points of the line

The bend points of the line when the element is moved, are at the adjacent points of elements.

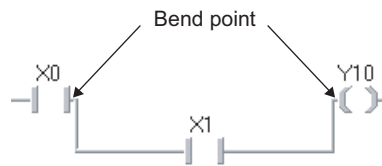

A bend point can be changed to any desired point by adding a bend point on the line as shown below.

When adding a bend point, select [Edit] ⇒ [Interconnect Mode] (  ).

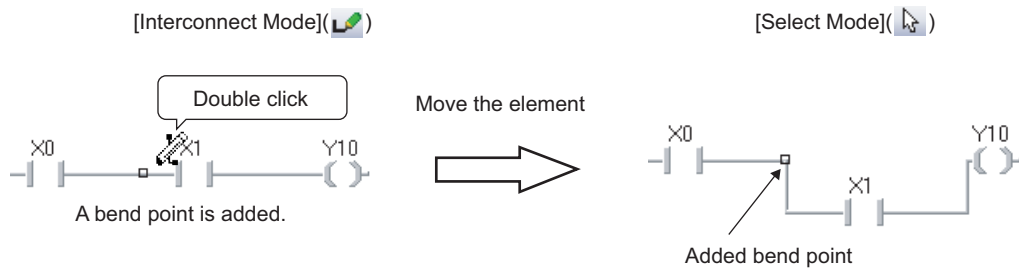

Note that when deleting the added bend point, delete not only the line but the bend point as well as shown below.



### ● Moving elements without lines connected

Even when the Auto connect function is enabled, the selected element can be moved without lines connected by dragging and dropping the element while holding down the **[Shift]** key.

### 8.4.3 Copying elements

Copy an element within the editor or to another Structured Ladder/FBD editor.

#### ● Copying elements with the drag-and-drop operation

Elements can be copied within the editor.

##### Operation

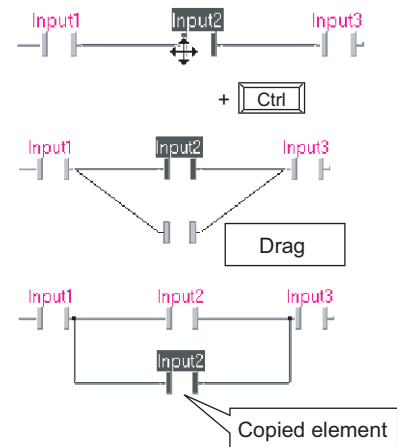

1. Hold down the **Ctrl** key and click the element.
2. Drag it to the desired position.



#### ● Copying elements using the clipboard

Elements can be copied within the same editor or to another Structured Ladder/FBD editor by the basic menu options using a clipboard or shortcut keys.

##### Operation

1. Select [Edit] ⇒ [Cut] (  )/[Copy] (  ).
2. Select [Edit] ⇒ [Paste] (  ).
3. Click the desired position. The upper left of the pasted position is the position to be clicked.

1  
OVERVIEW2  
SCREEN  
CONFIGURATION3  
PROGRAMMING  
PROCEDURE4  
PROGRAM  
CONFIGURATIONS5  
SETTING LABELS6  
COMMON  
OPERATIONS OF  
PROGRAM EDITORS7  
EDITING ST  
PROGRAMS8  
EDITING STRUCTURED  
LADDER/FBD  
PROGRAMS

### Point

#### ● Copying elements to other ladder blocks

Elements cannot be copied or moved to other ladder blocks with the drag-and-drop operation when the Auto connect function is enabled. In order to copy or move elements, execute one of the following operations.

- Dragging and dropping while holding down the **[Shift]** key, or **[Ctrl] + [Shift]** keys
- Disable the Auto connect function
- Using a clipboard

Select [Edit] ⇒ [Auto Connect] to switch the Auto connect function ON/OFF.

#### ● Copying elements with the drag-and-drop operation when the Auto connect function is enabled

The line of the copied element is connected automatically when the Auto connect function is enabled. If the line is not connected properly, or elements are overlapped, disable the Auto connect function by selecting [Edit] ⇒ [Auto Connect] (clear the check box) and correct the line.

#### ● Copying elements without lines connected

Even when the Auto connect function is enabled, the selected element can be copied without lines connected by dragging and dropping the element while holding down the **[Ctrl] + [Shift]** keys.

#### ● Cutting/copying elements using a clipboard

When cutting or copying elements using a clipboard, the selection range differs between left-clicking and right-clicking of a mouse.

Select the menu by left-clicking on the element to delete lines and the element.

Select the menu by right-clicking on the element to leave the lines and delete the element only.

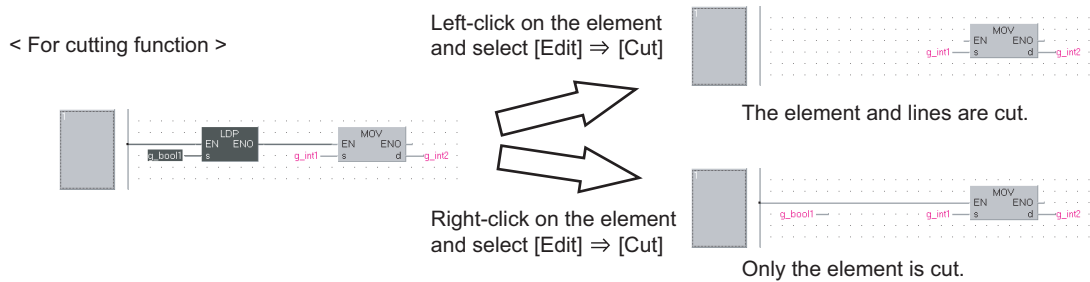

## 8.5 Changing Type of Contact and Coil

Q CPU L CPU FX

This section explains how to change the type of contact and coil.

### 8.5.1 Setting the type of contact and coil

The following table shows the types that can be set for contacts and coils.

	Type	Symbol
Contact*1	Open Contact	
	Close Contact	
	Rising Pulse*2	
	Falling Pulse*2	
	Rising Pulse Close*3	
	Falling Pulse Close*3	
Coil*1	Normal	
	Negation	
	Set	
	Reset	
Bit type input/output pin	Open Contact	
	Close Contact	
Jump	Open Contact	
	Close Contact	
Return	Open Contact	
	Close Contact	

\*1 : These items cannot be used for FBD.

\*2 : Not supported by FX0, FX0s, FX0N, FXu, FX2c.

\*3 : Supported by Universal model QCPU/LCPU.

1  
OVERVIEW2  
SCREEN  
CONFIGURATION3  
PROGRAMMING  
PROCEDURE4  
PROGRAM  
CONFIGURATIONS5  
SETTING LABELS6  
COMMON  
OPERATIONS OF  
PROGRAM EDITORS7  
EDITING ST  
PROGRAMS8  
EDITING STRUCTURED  
LADDER/FBD  
PROGRAMS

### Operating procedure

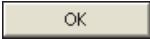
1. Select a contact or coil whose type is changed.
2. Select [Edit] ⇒ [Signal Configuration] ⇒ [Configure].
3. Select the type on the Signal Configuration screen.
4. Click the  button.  
The selected contact or coil is set.

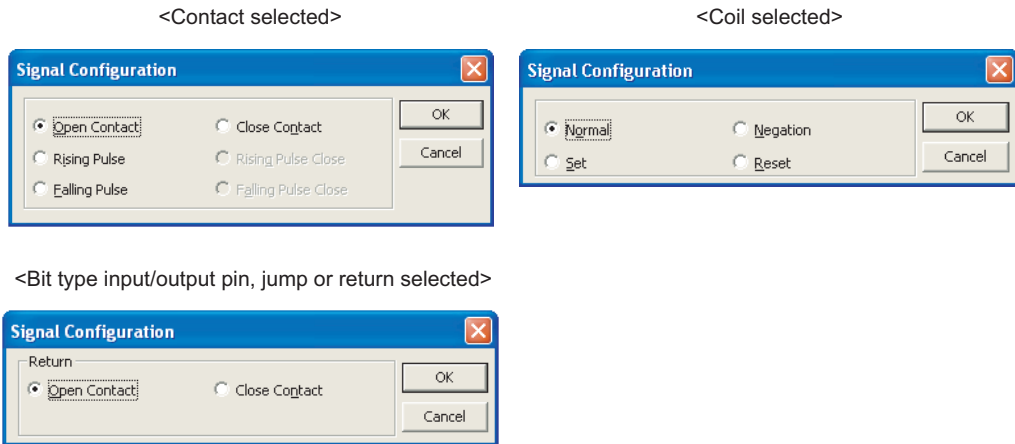

### Point

- **Setting the type of contact and coil**

The type of contact or coil can be set by double-clicking a contact or coil.

- **Bit type input/output pin**

For a bit type input pin and a bit type output pin connected to a POU such as an FB and function, its contact type of open/close can be changed.

To change the type of a contact, double-click on the position designated in the following figure, or click on the position designated in the following figure and select [Edit] ⇒ [Signal Configuration] ⇒ [Configure].

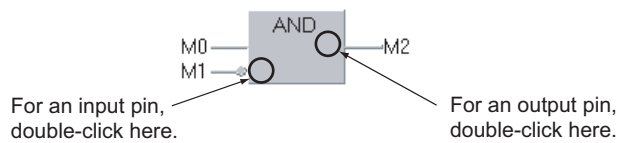



## 8.5.2 Changing contact and coil in predetermined order

The following table shows the order when changing the type of contact and coil.

Type	Change sequence
Contact*1	Open Contact → Close Contact → Rising Pulse <sup>2</sup> → Falling Pulse <sup>2</sup> → Rising Pulse Close <sup>3</sup> → Falling Pulse Close <sup>3</sup>
Coil*1	Normal → Negation → Set → Reset
Bit type input/output pin	Open Contact → Close Contact Label ← Label
Jump	Open Contact → Close Contact →Label ← →Label
Return	Open Contact → Close Contact -◀Return ▶ ← ◀Return ▶

\*1 : These items cannot be used for FBD.

\*2 : Not supported by FX0, FX0S, FX0N, FXU, FX2C.

\*3 : Supported by Universal model QCPU/LCPU.

### Operating procedure

1. Select a contact or coil.
2. Select [Edit] ⇒ [Signal Configuration] ⇒ [Toggle].

1 OVERVIEW

2 SCREEN CONFIGURATION

3 PROGRAMMING PROCEDURE

4 PROGRAM CONFIGURATIONS

5 SETTING LABELS

6 COMMON OPERATIONS OF PROGRAM EDITORS

7 EDITING ST PROGRAMS

8 EDITING STRUCTURED LADDER/FBD PROGRAMS

## 8.6 Operating Functions and Function Blocks

Q CPU L CPU FX

This section explains how to operate functions and function blocks.

### 8.6.1 Adding variables automatically when entering functions and function blocks

Configure the option setting in order to add input/output variables automatically when functions or function blocks are entered. (This setting is enabled only when the Auto connect function is activated.)

#### Operating procedure

1. Select [Tool] ⇒ [Options] ⇒ "Program Editor" ⇒ "Structured Ladder/FBD" ⇒ "FB/FUN".
2. Select "Automatic input/output labels".  
To add an output variable to ENO/VAR\_IN\_OUT, select "Automatic ENO labels"/"Add Automatic Output Variable to VAR\_IN\_OUT".
3. Select [Edit] ⇒ [Auto Connect].

<Without adding input/output variables>

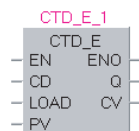

<Adding input/output variables>

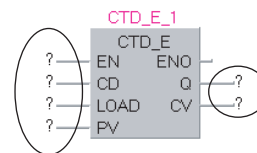

## 8.6.2 Editing variable names and instance names

Edit a variable name or function block instance name.

### Operating procedure

1. Click the entry field of an element such as a contact, coil, and input/output label.  
The entry field is enabled for editing.
2. Edit the variable name or instance name.

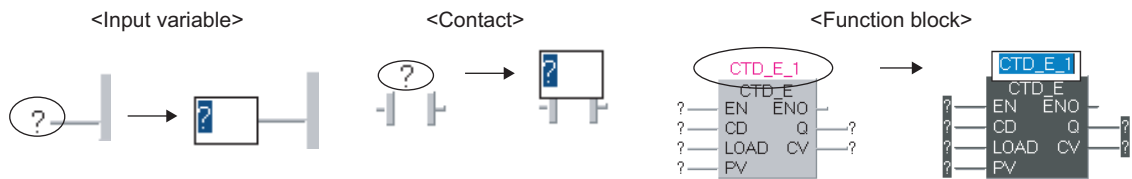

### Point

#### ● Using set label names

When the entry field is enabled for editing, a label name can be selected on the Label Registration/Selection screen by right-clicking the entry field and selecting [List Operands] (📄) from the shortcut menu.  
(📖 Section 6.2.2)

1  
OVERVIEW2  
SCREEN CONFIGURATION3  
PROGRAMMING PROCEDURE4  
PROGRAM CONFIGURATIONS5  
SETTING LABELS6  
COMMON OPERATIONS OF PROGRAM EDITORS7  
EDITING ST PROGRAMS8  
EDITING STRUCTURED LADDER/FBD PROGRAMS

### 8.6.3 Changing the number of arguments for functions and function blocks

Change the number of arguments of functions and function blocks in the application functions. For details of functions whose number of arguments can be changed, refer to the following manual.

☞ MELSEC-Q/L Structured Programming Manual (Application Functions)

☞ FXCPU Structured Programming Manual (Application Functions)

To add or delete an argument, select a function or a function block and proceed the following operation.

#### ● Adding an argument

##### Operation

- Select [Edit] ⇒ [Number of Pins] ⇒ [Increment] (  ).

#### ● Deleting an argument

##### Operation

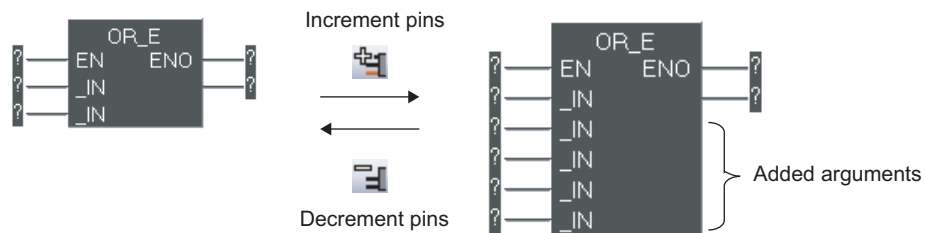

- Select [Edit] ⇒ [Number of Pins] ⇒ [Increment] (  ).



#### Point

#### ● Adding and deleting arguments

Arguments can also be added or deleted using the following method.

- Using the  or  key
- Changing the height of the element using the mouse



## 8.7.2 Displaying instance names in multiple lines

Display wrapped function block instance name within the width of function block by setting the option.

### Operating procedure

1. Select [Tool] ⇒ [Options] ⇒ "Program Editor" ⇒ "Structured Ladder/FBD" ⇒ "FB/FUN".
2. Select "Wrap instance name for function block".



## 8.7.3 Specifying the number of displaying characters for variable names

Change the number of displaying characters for variable names of functions and function blocks by setting the option.

### Operating procedure

1. Select [Tool] ⇒ [Options] ⇒ "Program Editor" ⇒ "Structured Ladder/FBD" ⇒ "FB/FUN".
2. Select "Specify the number of enable characters for label name/comment".
3. Set the number of characters (2 to 255).

A variable name is displayed according to the set number of lines and characters.

If all characters of the variable name cannot be displayed, ">" is appended after the last character.



## 8.7.4 Changing display format of variable

Change the display format of variable to the device/address/comment format.

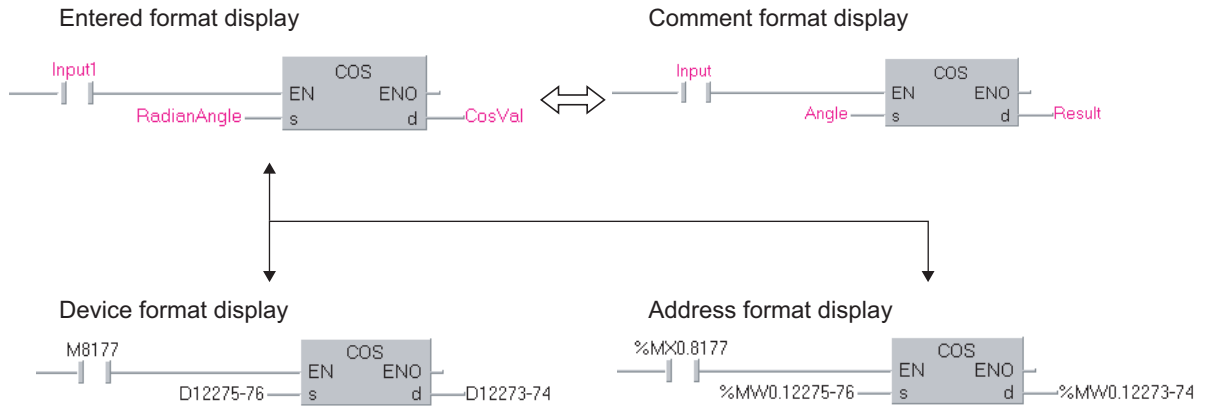

### ● Displaying in the entered format

#### Operation

- **Select [View] ⇒ [View Mode] ⇒ [Label].**  
Variables are displayed in the format as they are entered.

### ● Displaying in the device format

#### Operation

- **Select [View] ⇒ [View Mode] ⇒ [Device].**  
Entered format is displayed in the device format.  
As for labels, the assigned devices are displayed in the device format.

### ● Displaying in the address format

#### Operation

- **Select [View] ⇒ [View Mode] ⇒ [Address].**  
Devices are displayed in the address format.  
As for labels, the assigned devices are displayed in the address format.

### ● Displaying in the comment format

#### Operation

- **Select [View] ⇒ [View Mode] ⇒ [Comment].**  
For labels, label comments are displayed.  
As for devices/addresses, device comments are displayed.

### ● Switching label/device/address display

#### Operation

- **Select [View] ⇒ [View Mode] ⇒ [Change Label-Device-Address Mode].**  
The display is switched in order (label, device, address) by selecting the menu each time.

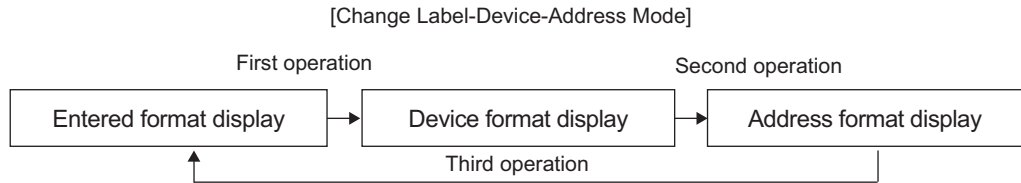

### ● Switching label/comment display

#### Operation

- **Select [View] ⇒ [View Mode] ⇒ [Change Label-Comment Mode].**  
The display is switched between label and comment by selecting the menu each time.

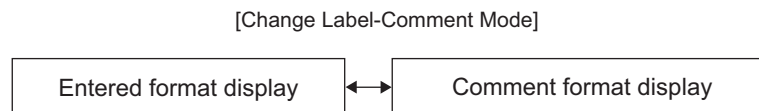

### ● Batch-changing display of all program editors to device format display

#### Operation

- **Select [View] ⇒ [All Device Display].**  
The display of all program editors (except for ST) being opened is changed to the device format display.

### ● Batch-canceling device format display on all program editors

#### Operation

- **Select [View] ⇒ [Cancel All Device Display].**  
The device format display of all program editors is canceled, and the display returns to the entered format.



**Point**

● **Displaying uncompiled labels and label comments**

An asterisk (\*) is prefixed to each label name of uncompiled labels to which devices are not assigned when the display format is changed to the device format or address format.  
 An asterisk (\*) is prefixed to each label name of labels to which label comments are not set when the display format is changed to the comment display.



● **Structure/function block labels**

Structure/function block labels are displayed as label names even when the display format is changed to the comment display.



● **Constant type labels**

When the display format is device format, constant type labels are displayed as constants set in a label setting editor. When the display format is address format, constant type labels are displayed as label names.

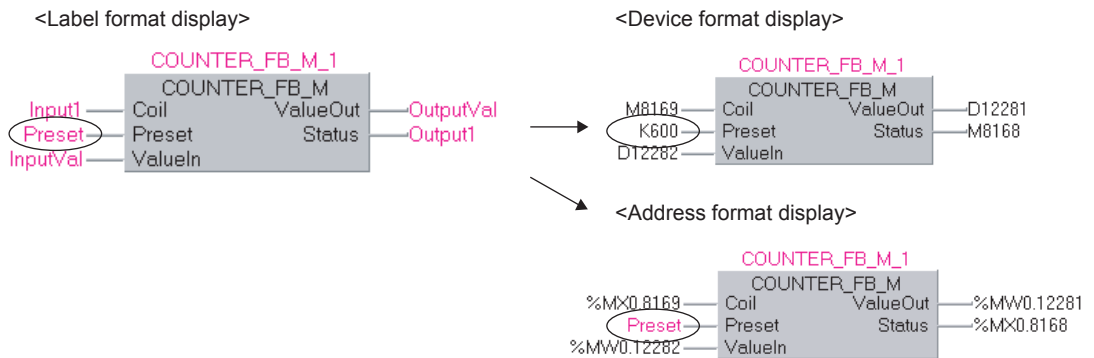

● **Restrictions on operations when changing the display format**

Program editing and search/replace functions are disabled in the device/address format or comment display. To operate these functions, return the setting to [Standard].

1	OVERVIEW
2	SCREEN CONFIGURATION
3	PROGRAMMING PROCEDURE
4	PROGRAM CONFIGURATIONS
5	SETTING LABELS
6	COMMON OPERATIONS OF PROGRAM EDITORS
7	EDITING ST PROGRAMS
8	EDITING STRUCTURED LADDERED PROGRAMS

### 8.7.5 Displaying additional label items

When [Label] is selected in [View Mode], the labels and other format such as device can be displayed at the same time.

For details of changing display format, refer to Section 8.7.4.

#### Operating procedure

- **Select [View] ⇒ [Add Label Display Items] ⇒ [Device]/[Address]/[Label Comment]/[Device Comment]**

The selected item is displayed.



#### Point

- **Switching to display/hide the multiple additional label items**

The additional label items can be displayed/hide in batch by setting the option.

Display/hide can be switched by selecting the item in [Tool] ⇒ [Option] ⇒ "Program Editor" ⇒ "Structured Ladder/FBD" ⇒ "Label" ⇒ "Add Label Display Items".

- **Items which can be displayed at the same time**

The items which can be displayed at the same time are different depending on the display format when the value is input.

○: Displayable -: Undisplayable

Additional label items	Format when a valuable is input		
	Label	Device	Address
Device	○	○	○
Address	○	○	○
Label Comment	○	-	-
Device Comment	-	○	○

- **If the devices assigned to label are not displayed**

The devices are not displayed in the following cases even the option is set.

- When the program is never compiled
- When the labels are used for array element
- When structure labels are used

- **Edit or search/replace the additional label items**

The additional label items cannot be edited or searched/replaced.

## 8.8 Editing Ladder Blocks

Q CPU L CPU FX

This section explains how to edit ladder blocks.

### 8.8.1 Inserting ladder blocks

Add or insert a new ladder block.

#### ● Inserting a ladder block at the start

##### Operation

- Select [Edit] ⇒ [New Ladder Block List] ⇒ [Top].  
A new ladder block is inserted at the start of all ladder blocks.

#### ● Inserting a ladder block in front of the current ladder block

##### Operation

- Select [Edit] ⇒ [New Ladder Block List] ⇒ [Before] (  ).  
A new ladder block is inserted in front of the ladder block being edited.

#### ● Inserting a ladder block in front of the current ladder block

##### Operation

- Select [Edit] ⇒ [New Ladder Block List] ⇒ [After] (  ).  
A new ladder block is inserted in back of the ladder block being edited.

#### ● Inserting a ladder block at the end

##### Operation

- Select [Edit] ⇒ [New Ladder Block List] ⇒ [Bottom].  
A new ladder block is inserted at the end of all ladder blocks.

### 8.8.2 Deleting ladder blocks

Delete a selected ladder block.

#### Operating procedure



- Select [Edit] ⇒ [Delete].

1  
OVERVIEW2  
SCREEN CONFIGURATION3  
PROGRAMMING PROCEDURE4  
PROGRAM CONFIGURATIONS5  
SETTING LABELS6  
COMMON OPERATIONS OF PROGRAM EDITORS7  
EDITING ST PROGRAMS8  
EDITING STRUCTURED LADDER/FBD PROGRAMS

### 8.8.3 Cutting, copying, pasting, and moving ladder blocks

Cut/copy/paste/move ladder blocks within the editor or to another program editor on the screen. Ladder blocks can be pasted/moved between program editors with the same programming language.

#### Operating procedure

1. Select a ladder block by clicking the ladder block header.
2. Select [Edit] ⇒ [Cut] (  )/[Copy] (  ).
3. Select a ladder block to which cut/copied ladder block is pasted, and select [Edit] ⇒ [Paste] (  ).

A cut/copied ladder block is inserted above the selected ladder block.

#### ■ Copying/moving ladder blocks with the drag-and-drop operation

To copy/move ladder blocks, click the ladder block header, and drag and drop the ladder block.

##### ● Copy

#### Operation

- Click the ladder block header, and drag and drop it while holding down the  key. The ladder block is copied.



##### ● Move

#### Operation

- Click the ladder block header, and drag and drop it. The ladder block is moved. The ladder block can be moved only within the same editor.

#### Point

##### ● Operations when dragging and dropping ladder blocks

- To cancel the copy/move operation, press the  key during the drag-and-drop operation.
- To switch the copy/move operations, press the  key during the drag-and-drop operation. (Different icons are displayed for the copy and move operations.)

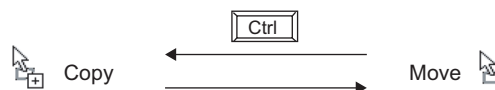

## 8.8.4 Editing ladder block headers

A ladder block header is an area that displays information set for each ladder block. Create a ladder block label and ladder block title.

### Screen display

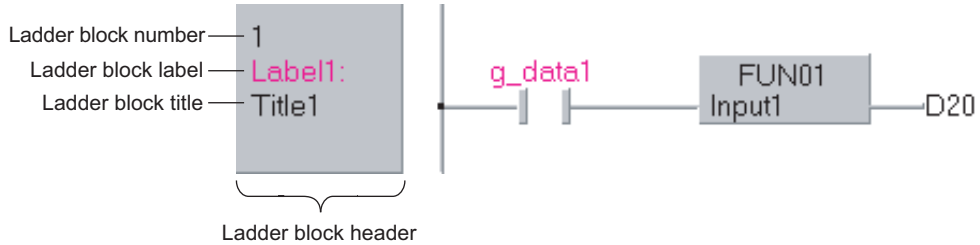

### Display contents

Name	Description
Ladder block number	A number automatically assigned from the start.
Ladder block label	Enter a character string to be specified as the jump target when using the jump instruction. A colon (:) needs to be entered at the end of the character string. A maximum number of characters that can be entered is 7.
Ladder block title	Enter a meaning of the program as a title when necessary. A maximum number of characters that can be entered is 20.

### Operating procedure

1. Double-click the ladder block header. The Ladder Block screen is displayed.

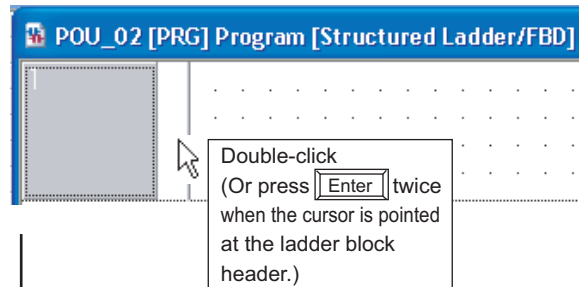

2. Enter the ladder block label and ladder block title.

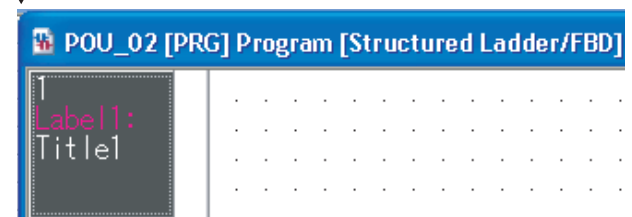
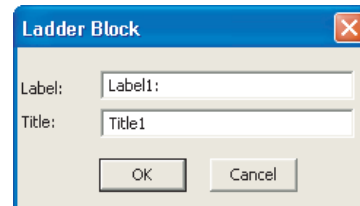

1 OVERVIEW

2 SCREEN CONFIGURATION

3 PROGRAMMING PROCEDURE

4 PROGRAM CONFIGURATIONS

5 SETTING LABELS

6 COMMON OPERATIONS OF PROGRAM EDITORS

7 EDITING ST PROGRAMS

8 EDITING STRUCTURED LADDER/FBD PROGRAMS

## 8.8.5 Editing listed ladder blocks

Edit the listed ladder block header information.

### Screen display

Select [Edit] ⇒ [Ladder Block List].

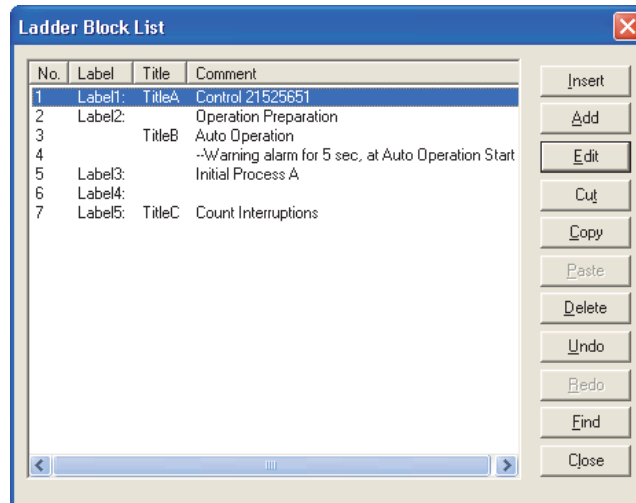

### Display contents

Item	Description
No.	Displays ladder block numbers.
Label	Displays ladder block labels.
Title	Displays ladder block titles.
Comment	Displays ladder block comments. When multiple ladder block comments exist in the ladder block, the comment placed on the upper left is displayed.

### Screen button

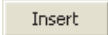
- 

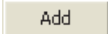
Inserts a new ladder block in front of the selected ladder block.
- 

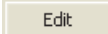
Inserts a new ladder block at the end of the existing ladder blocks.
- 

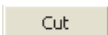
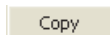
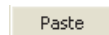
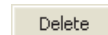
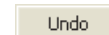
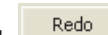
Displays an editing screen of the ladder block header. Ladder block labels and ladder block titles can be edited. (☞ Section 8.8.6)  
Ladder block comments can be edited on the Structured Ladder/FBD editor. (☞ Section 8.9)
-  ,  ,  ,  ,  , 

Same functions as the buttons on program editors.  
Cut/copy/paste/delete operation can be performed in units of ladder block.



The Search Ladder Block screen is displayed. The character strings in the ladder block list can be searched.

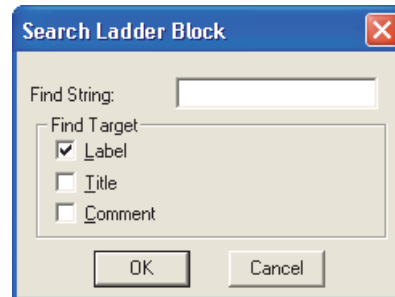

### Operation

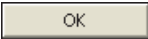
1. Input the character string and select the search target.
2. Click the  button.  
Search the character strings after the selected line.  
The cursor is moved to a line where the searched character string is partially matched.

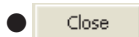

Closes the Ladder Block List screen.

1  
OVERVIEW2  
SCREEN  
CONFIGURATION3  
PROGRAMMING  
PROCEDURE4  
PROGRAM  
CONFIGURATIONS5  
SETTING LABELS6  
COMMON  
OPERATIONS OF  
PROGRAM EDITORS7  
EDITING ST  
PROGRAMS8  
EDITING STRUCTURED  
LADDER/FBD  
PROGRAMS

## 8.8.6 Setting ladder block labels/titles

Set a ladder block label/title.

### Operating procedure

1. Select [Edit] ⇒ [Ladder Symbol] ⇒ [Ladder Block Label].

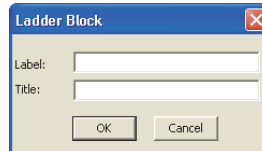

2. Set the ladder block label and ladder block title, and click the  button.

## 8.8.7 Switching to display/hide left power rail

Switch to display/hide left power rail for each ladder block.  
When using FBD, switch the left power rail to hide.

### Operating procedure

- Select a ladder block, and select [Edit] ⇒ [Ladder Symbol] ⇒ [Left Power Rail] (  ).  
The left power rail of selected ladder block is switched to display/hide.

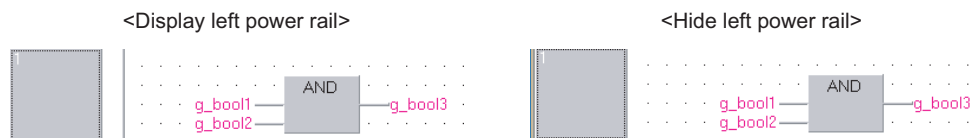



**Restrictions**

● **Entering position of line when hiding left power rail**

When a vertical line is entered on the position of left power rail, the vertical line is regarded as the left power rail. When entering a vertical line, avoid the left power rail position.

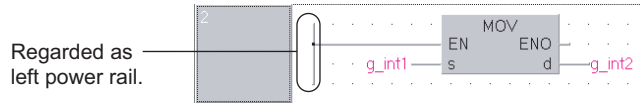

If a line is entered on the position of left power rail as shown below, a warning message "Multiple ladders in one network. (C2034)" is displayed on the Output window at compilation.

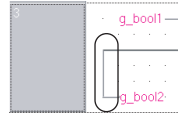

● **Compilation result when FBD is used**

When multiple ladder blocks are created for single ladder block, a warning message "Multiple ladders in one network. (C2034)" is displayed on the Output window at compilation.

Disabling the warnings is recommended when FBD is used.

Set the warning code "C2034" under [Tool] ⇒ [Options] ⇒ "Compile" ⇒ "Output Result" ⇒ "Disable Warning and Notification Message". (Section 10.4.2)

● **Connecting to left power rail**

As shown in the following figure, a line cannot be connected to the left power rail directly when a line is branched with a line.

Place SM400 before the branch point to always turn ON the input from the left power rail.

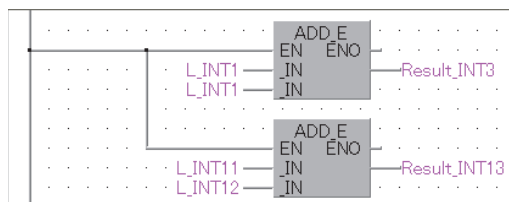
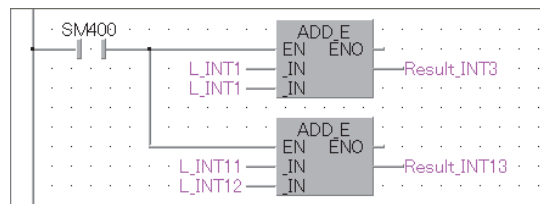

**8.8.8 Displaying grid**

A grid indicates specific positions, such as tab stop positions and the start/end position of a line, on a program editing area. Switch the grid display on a program editing area.

**Operating procedure**

- Select [View] ⇒ [Grid].



1	OVERVIEW
2	SCREEN CONFIGURATION
3	PROGRAMMING PROCEDURE
4	PROGRAM CONFIGURATIONS
5	SETTING LABELS
6	COMMON OPERATIONS OF PROGRAM EDITORS
7	EDITING ST PROGRAMS
8	EDITING STRUCTURED LADDER/FBD PROGRAMS

## 8.9 Editing Comments

Q CPU L CPU FX

This section explains how to edit comments.

Comments can be entered in the same manner as elements. (☞ Section 8.2.1)

### Operating procedure

- Select [Edit] ⇒ [Ladder Symbol] ⇒ [Comment] (  ).

### 8.9.1 Editing comments

Edit a comment.

#### Operating procedure

**1. Click the comment.**

The comment entry field is enabled.

**2. Enter a comment.**

Press the  +  keys to insert a line feed.

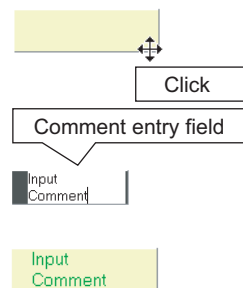

### 8.9.2 Changing the size of comment entry field

Change the size of a comment entry field.

After changing to the Select Mode, change the size by the following procedure. (☞ Section 8.1.1)

#### Operating procedure

**1. Click the position where the cursor changes to  on the corner of the comment entry field.**



**2. Drag the corner to adjust the size.**

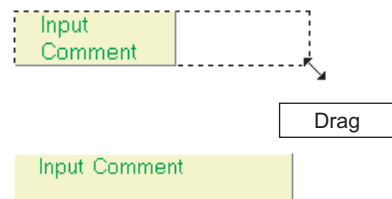

## 8.9.3 Moving comments

Move a comment.

Comments can be moved only within the same ladder block.

### Operating procedure

1. Click the position where the cursor changes to  on the comment entry field.
2. Drag it to the desired position.

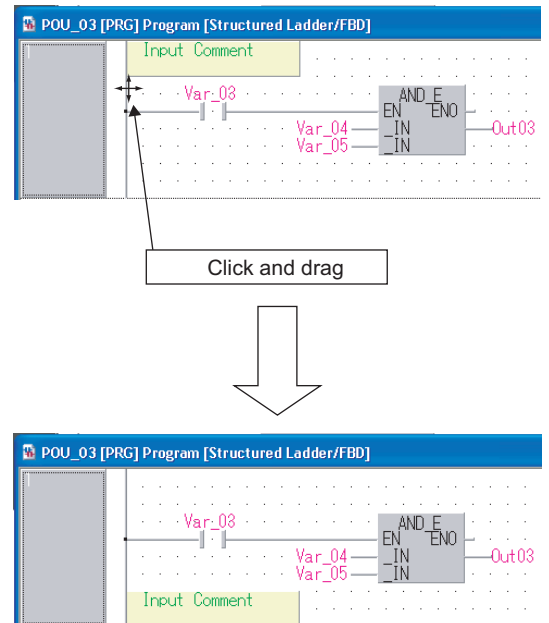
1  
OVERVIEW2  
SCREEN CONFIGURATION3  
PROGRAMMING PROCEDURE4  
PROGRAM CONFIGURATIONS5  
SETTING LABELS6  
COMMON OPERATIONS OF PROGRAM EDITORS7  
EDITING ST PROGRAMS8  
EDITING STRUCTURED LADDER/FBD PROGRAMS

## 8.10 Editing in Guided Mode

Q CPU L CPU FX

This section explains how to edit programs in the Guided mode, which is convenient when data is entered mainly from the keyboard.

### Screen display

Select [Edit] ⇒ [Guided Mode] ⇒ [Guided Editing] (  ).

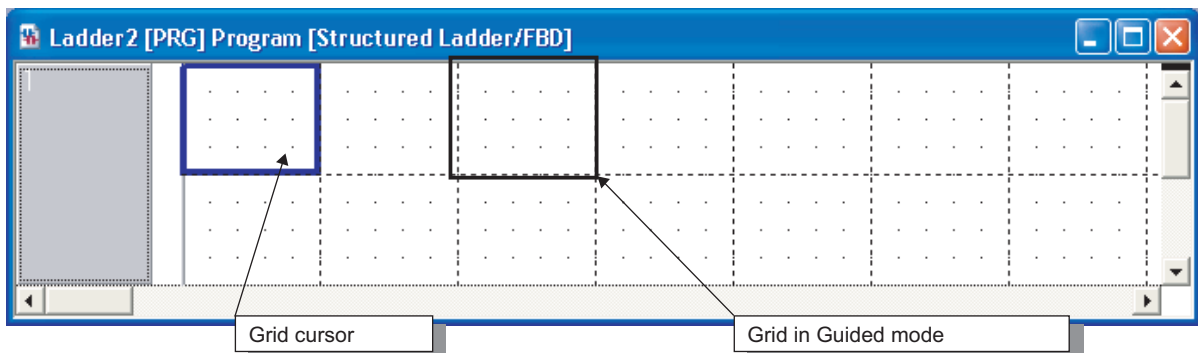

### 8.10.1 Overwrite mode and insert mode

Select either overwrite mode or insert mode in the Guided mode.

Edit	Description	Grid cursor color
Overwrite Mode	Overwrites the existing element at the cursor position with the entered element.	Blue
Insert Mode	Moves the existing element at the cursor position to the right and inserts an element.	Purple

For switching between overwrite and insert modes, follow the operation below.

#### Operating procedure

- Select [Edit] ⇒ [Guided Mode] ⇒ [Overwrite Mode]/[Insert Mode].  
The mode changes between overwrite and insert, and the grid cursor color changes.

#### Point

- **Switching "Overwrite Mode" and "Insert Mode"**  
The mode can also be switched by pressing the  key.

## 8.10.2 Entering elements

The element entry method in the Guided mode is the same as that of the Select mode.  
For entering elements, refer to the following section.

☞ Section 8.2.1 "Entering elements"

## 8.10.3 Entering instructions





The instruction entry method in the Guided mode is the same as that of the Select mode.  
For entering instructions, refer to the following section.

☞ Section 8.2.2 "Entering instructions"

## 8.10.4 Connecting elements with lines

Connect the entered elements with a line.

### Operating procedure

1. **Select [Edit] ⇒ [Guided Mode] ⇒ [Line Mode].**  
The thickness of grid cursor is doubled. The normal grid in the Guided mode is divided into 4×5 parts of smaller grids to specify a position.
2. **Move the cursor to the position where the line is to be connected by pressing the  /  key.**
3. **Press the  button (Horizontal line).**  
A horizontal line is drawn by the length of one divided grid.
4. **Press the  button (Vertical line).**  
A vertical line is drawn by the length of one divided grid.

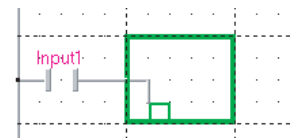
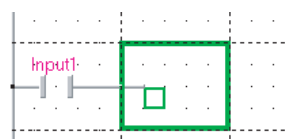
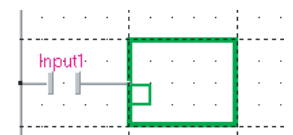
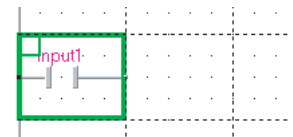
1  
OVERVIEW2  
SCREEN  
CONFIGURATION3  
PROGRAMMING  
PROCEDURE4  
PROGRAM  
CONFIGURATIONS5  
SETTING LABELS6  
COMMON  
OPERATIONS OF  
PROGRAM EDITORS7  
EDITING ST  
PROGRAMS8  
EDITING STRUCTURED  
LADDER/FBD  
PROGRAMS

### 8.10.5 Drawing lines



Draw a line.

#### Operating procedure

1. Select [Tool] ⇒ [Options] ⇒ "Program Editor" ⇒ "Structured Ladder/FBD" ⇒ "Guided".
2. Select "Allow hotkey repeater".

Draw a line using the Horizontal Line Segment or Vertical Line Segment screen.

#### Operating procedure

1. Press the  (Horizontal line) or  (Vertical line) button.

The Horizontal Line Segment or Vertical Line Segment screen is displayed.

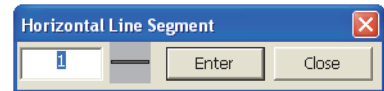

2. Set the length of the line to be drawn using the divided grid width/height as the unit of length.

A line of the specified length is displayed.

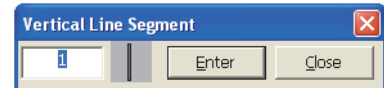

### 8.10.6 Wrapping lines

Wrap a line if it does not fit in a single rung.

#### Operating procedure

1. Select [Tool] ⇒ [Options] ⇒ "Program Editor" ⇒ "Structured Ladder/FBD" ⇒ "Guided".

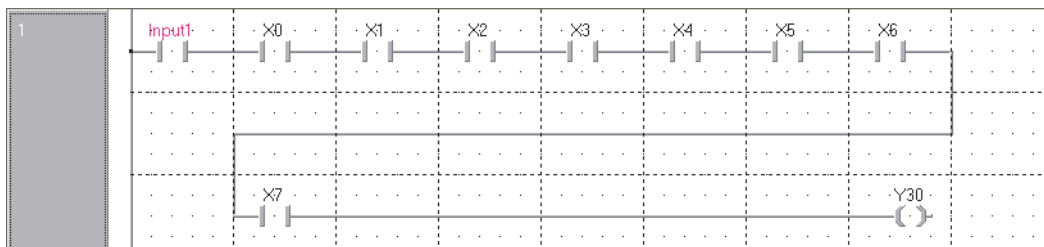

2. Select "Ladder Wrapping".

#### Point

##### ● Target of wrapping line to be displayed

Ladder programs edited after setting the above option are wrapped. (The display of edited ladder programs before setting the above option is not changed.)

## 8.10.7 Setting Guided mode as the default editing mode

Set the Guided mode as the default editing mode of the Structured Ladder/FBD editor.

### Operating procedure

1. Select [Tool] ⇒ [Options] ⇒ "Program Editor" ⇒ "Structured Ladder/FBD" ⇒ "Guided".
2. Select "Open Structured Ladder/FBD Editor in guided mode".

## 8.10.8 Entering variable names after contacts and coils

Enter variable names continuously after a contact or a coil is entered.

### Operating procedure

1. Select [Tool] ⇒ [Options] ⇒ "Program Editor" ⇒ "Structured Ladder/FBD" ⇒ "Guided".
2. Select "Enter label names after contacts and coils".

1  
OVERVIEW2  
SCREEN  
CONFIGURATION3  
PROGRAMMING  
PROCEDURE4  
PROGRAM  
CONFIGURATIONS5  
SETTING LABELS6  
COMMON  
OPERATIONS OF  
PROGRAM EDITORS7  
EDITING ST  
PROGRAMS8  
EDITING STRUCTURED  
LADDER/FBD  
PROGRAMS

## 8.10.9 Inserting comment entry fields to ladder blocks to be added

Insert a comment entry field at the top of a ladder block in the Guided mode.

### Operating procedure

1. Select [Edit] ⇒ [Guided Mode] ⇒ [Auto Comment] (  ).

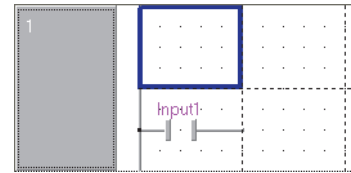

2. Select [Edit] ⇒ [New Ladder Block List] ⇒ [Before] (  ).

A ladder block with a comment entry field is added.

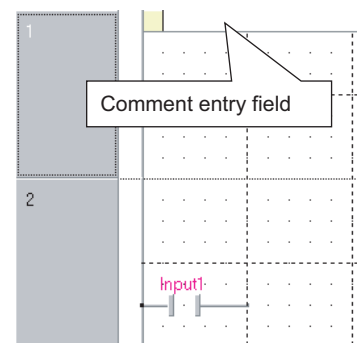

### Point

- **Width of automatically inserted comment**

The width of automatically inserted comment can be changed by the following operation.

Select [Tool] ⇒ [Options] ⇒ "Program Editor" ⇒ "Structured Ladder/FBD" ⇒ "Guided", and set "Auto Comment Block Width".

- **Entering a comment in the desired grid**

Hold down the  key and press the  key, and a comment can be entered to the grid at the cursor position.

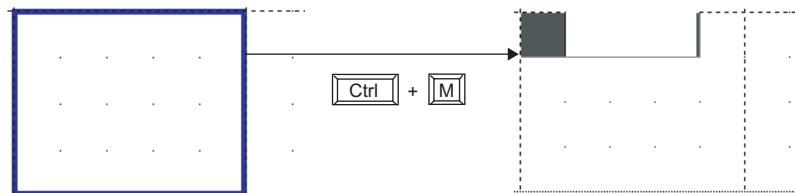



## 8.11 Checking Wrapping Position for Printing

Q CPU L CPU FX

This section explains how to display the wrapping positions of ladder for printing window.

### Operating procedure

- Select [View] ⇒ [Print Wrap Position].  
The wrapping position for printing window is displayed.

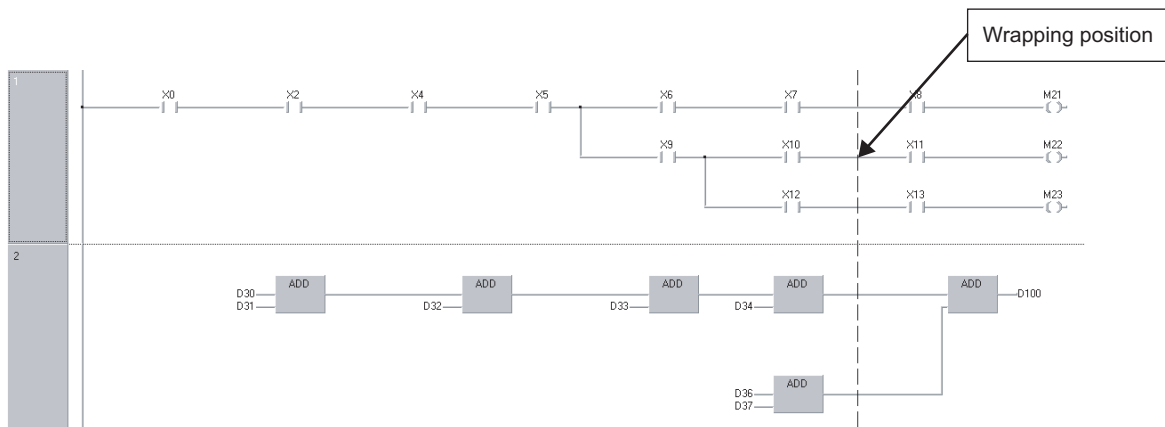

### Point

- **Wrapping positions**  
When the paper size is changed by the print setting, the wrapping positions are adjusted automatically.

1 OVERVIEW

2 SCREEN CONFIGURATION

3 PROGRAMMING PROCEDURE

4 PROGRAM CONFIGURATIONS

5 SETTING LABELS

6 COMMON OPERATIONS OF PROGRAM EDITORS

7 EDITING ST PROGRAMS

8 EDITING STRUCTURED LADDER/FBD PROGRAMS





# 9

# SEARCHING FOR SPECIFIC POSITION

This chapter explains how to move to a specified position in the program.

9.1	Searching for Specific Position in ST Program	9 - 2
9.2	Searching for Specific Position in Structured Ladder/ FBD Program	9 - 4

SEARCHING FOR SPECIFIC POSITION	9
CONVERTING/COMPILING PROGRAMS	10
WRITING/READING DATA TO/FROM PROGRAMMABLE CONTROLLER CPU	11
MONITORING	12
USING USER LIBRARIES	13
SETTING OPTIONS	14
APPENDIX	A
INDEX	I

## 9.1 Searching for Specific Position in ST Program

Q CPU L CPU FX

This section explains how to search for a specific position in the ST program.

For searching for devices and instructions, refer to the following manual.

☞ GX Works2 Version 1 Operating Manual (Common)

### 9.1.1 Jumping to specified line

The cursor jumps to the specified line.

#### Screen display

Select [Find/Replace] ⇒ [Jump].

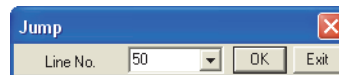

#### Operating procedure

1. Set the item on the screen.

Item	Description
Line No.	Enter a line number to which the cursor jumps. Click  to select a line number from the list of previously searched lines.

2. Click the  button.

The cursor jumps to the specified line.

### 9.1.2 Using bookmarks

Use bookmarks that are placed at positions in a program for frequent reference.

Bookmarks allow quick reference to specific positions in a program.

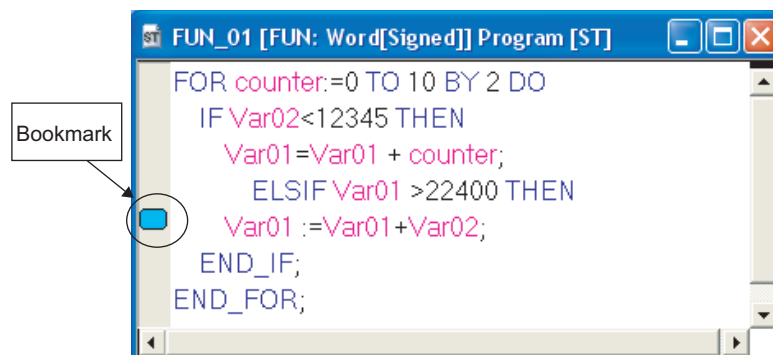

## ● Setting/canceling a bookmark

### Operation

- Select [Find/Replace] ⇒ [Bookmark] ⇒ [Toggle Bookmark] (📌)  
A new bookmark is set at, or the existing bookmark is cleared from, the line where the cursor is placed.

## ● Jumping from bookmark list

### Operation

1. Select [Find/Replace] ⇒ [Bookmark] ⇒ [Bookmark List] (📌)  
All registered bookmarks are displayed.

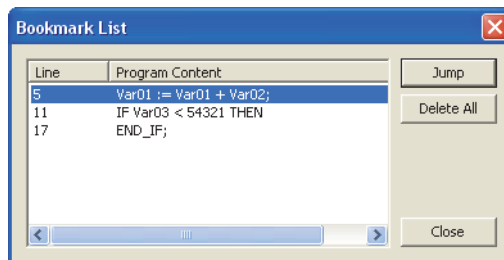

2. Select a bookmark to which the cursor jumps.
3. Click the  button, or double-click the selected line.  
The cursor moves to the line where the bookmark is set.  
Click the  button to cancel all bookmarks.

## ● Moving to the next bookmark

### Operation

- Select [Find/Replace] ⇒ [Bookmark] ⇒ [Next Bookmark] (📌)  
The cursor moves to the start of the line where the next bookmark is placed.

## ● Moving to the previous bookmark

### Operation

- Select [Find/Replace] ⇒ [Bookmark] ⇒ [Previous Bookmark] (📌)  
The cursor moves to the start of the line where the preceding bookmark is placed.

## ● Deleting all bookmarks

### Operation

- Select [Find/Replace] ⇒ [Bookmark] ⇒ [Delete All Bookmarks] (🗑️)  
All bookmarks are deleted.

SEARCHING FOR SPECIFIC POSITION	9
CONVERTING/COMPILING PROGRAMS	10
WRITING/READING DATA TO/FROM PROGRAMMABLE CONTROLLER CPU	11
MONITORING	12
USING USER LIBRARIES	13
SETTING OPTIONS	14
APPENDIX	A
INDEX	I

## 9.2 Searching for Specific Position in Structured Ladder/FBD Program

Q CPU L CPU FX

This section explains how to search for a specific position in the Structured Ladder/FBD program. For searching for devices and instructions, refer to the following manual.

☞ GX Works2 Version 1 Operating Manual (Common)

### 9.2.1 Jumping to specified ladder block number

The cursor jumps to the specified ladder block.

#### Screen display

Select [Find/Replace] ⇒ [Jump].

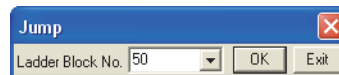

#### Operating procedure

1. Set the item on the screen.

Item	Description
Ladder Block No.	Enter a ladder block number to which the cursor jumps. Click  to select a ladder block from the list of previously searched ladder blocks.

2. Click the  button.

The cursor jumps to the specified ladder block.



# 10 CONVERTING/ COMPILING PROGRAMS

This chapter explains how to convert/compile created programs.

Programs are converted/compiled to sequence programs that can be executed on the programmable controller CPU.

10.1	Converting/Compiling Created Programs	10 - 2
10.2	Compiling All Programs	10 - 4
10.3	Executing Online Program Change Simultaneously with Conversion/Compilation	10 - 6
10.4	Changing Operating Conditions of Compilation	10 - 6
10.5	Compilation	10 - 15
10.6	Checking for Errors and Warnings	10 - 23

## 10.1 Converting/Compiling Created Programs

Q CPU L CPU FX

This section explains how to compile uncompiled program blocks among all program blocks that are registered to tasks.

Since this process compiles only uncompiled programs, the compiling time can be reduced.

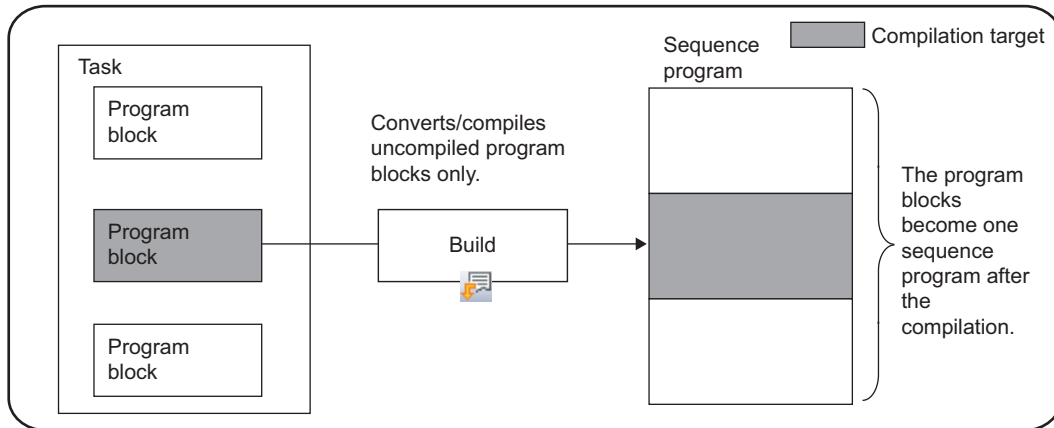

### Point

#### ● Conversion and compilation

The following explains the difference between conversion and compilation.

Conversion: Confirms edited content of ladder/SFC programs.

Compilation: Assigns devices to labels and creates a code to execute the program on a programmable controller CPU.

### Operating procedure

- Select [Compile] ⇒ [Build] (  ).

Programs are compiled and the result is displayed on the Output window.

By double-clicking the result (errors/warnings only), the corresponding error location in the program is displayed.

For checking errors/warnings, refer to Section 10.6.

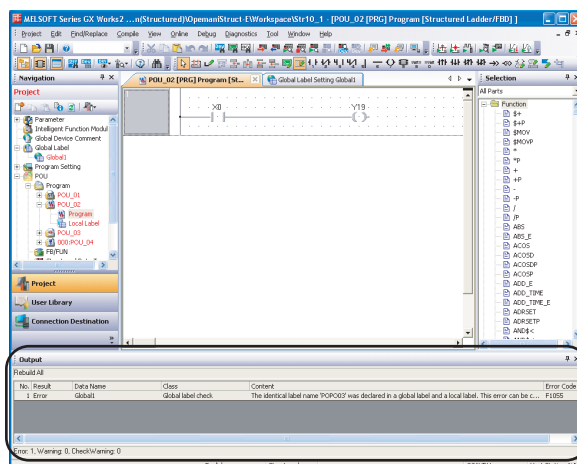

Output window



**Point** 

- **Compiling programs when adding/changing labels**  
For considerations for compiling programs when adding/changing labels, refer to Section 10.5.3.
- **Saving project automatically after compiling programs**  
A project can be saved automatically after compiling programs by setting the option.  
Select "Save project after compiling" under [Tool] ⇒ [Options] ⇒ "Project" ⇒ "Automatic Save".

SEARCHING FOR SPECIFIC POSITION	9
CONVERTING/COMPILING PROGRAMS	10
WRITING/READING DATA TO/FROM PROGRAMMABLE CONTROLLER CPU	11
MONITORING	12
USING USER LIBRARIES	13
SETTING OPTIONS	14
APPENDIX	A
INDEX	I

## 10.2 Compiling All Programs

Q CPU L CPU FX

This section explains how to batch compile all program blocks that are registered to tasks.

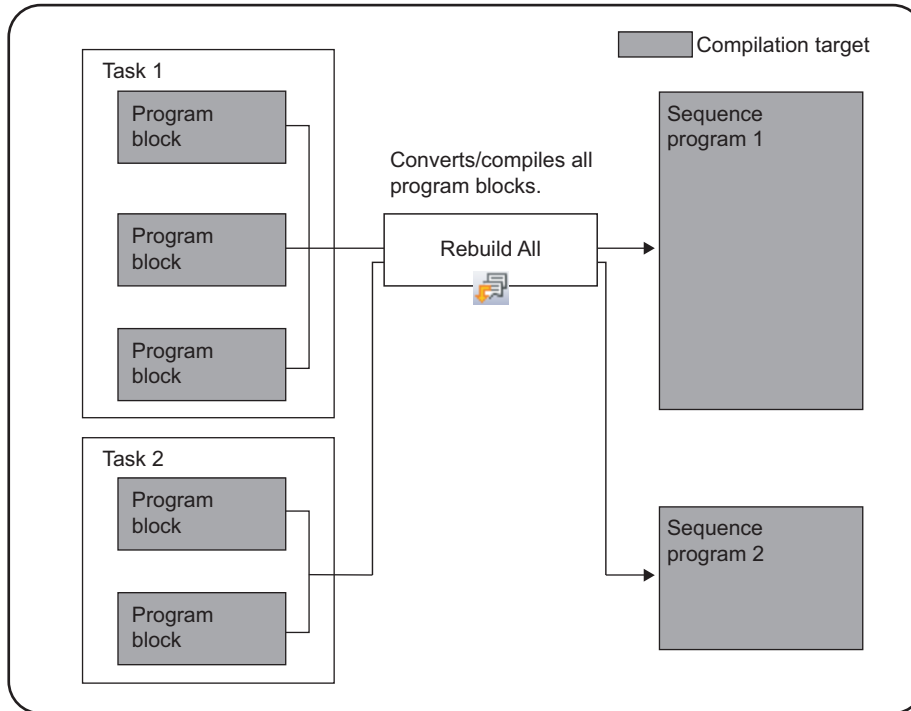

### Operating procedure

1. Select [Compile] ⇒ [Rebuild All] (🔄).

The following message is displayed.

Clear the check box if the duplicated coil check, ladder check, and consistency (pairing) check are not performed after the compilation.

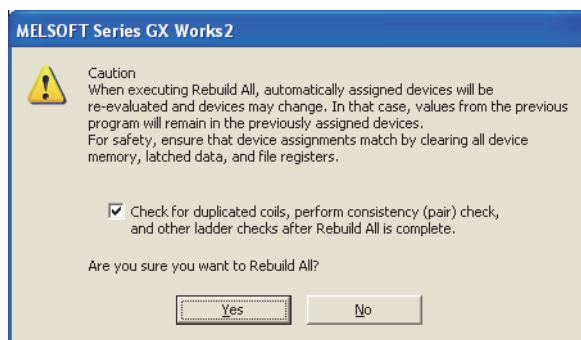

## 2. Execute the compilation after reading and understanding the considerations described on the message.

All programs are converted/compiled and the result (errors/warnings only) is displayed on the Output window.

By double-clicking the result, the corresponding error location in the program is displayed.

For checking errors/warnings, refer to Section 10.6.

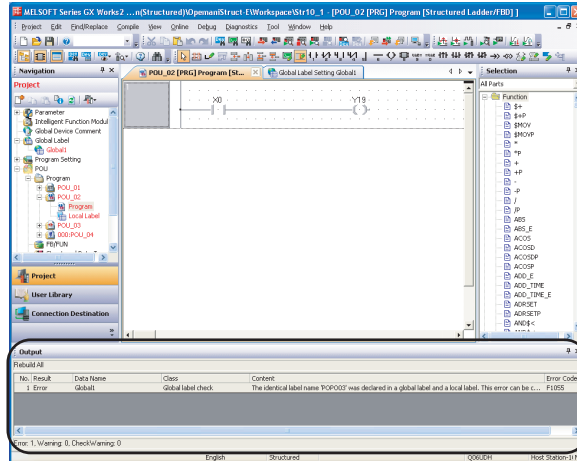

Output window

### Point

#### ● Assigning devices to labels when compiling all programs

For assigning devices to labels when compiling all programs, refer to Section 10.5.

#### ● When do not check duplicated coils for SET instruction

By setting the following option, SET instructions will not be detected as duplicated coils.

Select "Do not target the SET instruction for duplicated coil check" under [Tool] ⇒ [Options] ⇒ "Compile" ⇒ "Basic Setting".

#### ● Saving project automatically after compiling programs

A project can be saved automatically after compiling programs by setting the option.

Select "Save project after compiling" under [Tool] ⇒ [Options] ⇒ "Project" ⇒ "Automatic Save".

9

SEARCHING FOR  
SPECIFIC  
POSITION

10

CONVERTING/  
COMPILING  
PROGRAMS

11

WRITING/READING DATA  
TO/FROM PROGRAMMABLE  
CONTROLLER CPU

12

MONITORING

13

USING USER  
LIBRARIES

14

SETTING OPTIONS

A

APPENDIX

I

INDEX

## 10.3 Executing Online Program Change Simultaneously with Conversion/Compilation

Q CPU L CPU FX

For the operation for executing the Online program change simultaneously with the conversion/ compilation, refer to the following manual.

☞ GX Works2 Version 1 Operating Manual (Common)

## 10.4 Changing Operating Conditions of Compilation

Q CPU L CPU FX

This section explains how to change the operating conditions of compilation.

### 10.4.1 Changing the number of errors and warnings that stop compilation

Change the number of errors and warnings that stop compilation.

If the number of errors and warnings that occurred during compilation reaches the specified value, the compilation is aborted.

#### Screen display

Select [Tool] ⇒ [Options] ⇒ "Compile" ⇒ "Output Result".

#### Operating procedure

- Set the items on the screen.

Item	Description
Error	Set the number of errors that stops compilation (1 to 9999).
Warning	Set the number of warnings that stops compilation (1 to 9999).

## 10.4.2 Hiding warning messages

Hide messages displayed on the Output window when compiling programs.  
The registered warnings are not displayed on the Output window.

### Screen display

Select [Tool] ⇒ [Options] ⇒ "Compile" ⇒ "Output Result".



### Operating procedure

- To register the warnings, enter the warning code and click the **Add** button.  
The registered warnings are not displayed on the Output window.



- To cancel the registration, select the warning code and click the **Delete** button.  
The unregistered warnings are displayed on the Output window.



### Point

- **Warning codes**  
Warning codes and their content can be checked on the Output window when compiling programs.  
(☞ Section 10.6)
- **Maximum number of warnings to be invalidated**  
A maximum number of warnings to be invalidated is 100.

### 10.4.3 Using same name for global label and local label

Use the same name for a global label and a local label.

#### Operating procedure

1. Select [Tool] ⇒ [Options] ⇒ "Compile" ⇒ "Basic Setting".
2. Select "Use the same label name in global label and local label".
  - If all check boxes are cleared, an error occurs when compiling programs.
  - If this check box is selected, a warning is displayed when compiling programs. (Same label names can be used)

### 10.4.4 Using same lower case label name as device

Use a label name (for example: m0, x1F) that contains a lower case of alphabetic part of the device.

#### Operating procedure

1. Select [Tool] ⇒ [Options] ⇒ "Compile" ⇒ "Structured Ladder/FBD/ST" ⇒ "Compile Condition1".
2. Select "Use lower-case device names as labels".
  - If this check box is cleared, an error occurs when compiling programs.
  - If this check box is selected, a warning is displayed when compiling programs. (Label names that contain a same lower case as the device can be used.)

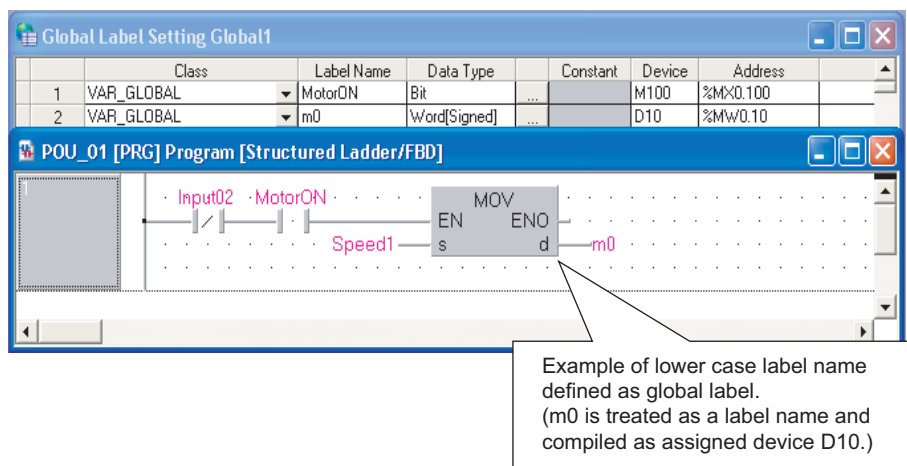

**Point**

● **Label names which cannot be used**

When a device name is written in upper case, and device number contains lower case in alphabetic part, device whose device number is hexadecimal (such as W device) may cause a compilation error, even "Options" is enabled. For example, "W0a1", "W1a" are regarded as devices, therefore, a compilation error is caused. "Wa1" can be used as a label when no numbers exist between device name and device number, even a device name is written in upper case, and device number contains lower case in alphabetic part.

● **Inline structured text**

For inline structured text, the devices within the range set on the <<Device>> tab of PLC parameter cannot be used as labels. Use the devices out of range set on the <<Device>> tab of PLC parameter.

### 10.4.5 Connecting PLS, PLF, or ALT outputs directly to other inputs with lines

Connect outputs of the selected function(s) (PLS, PLF, or ALT\*1) directly to other inputs with lines.

\*1 : Supported by FXCPU only.

**Operating procedure**

1. Select [Tool] ⇒ [Options] ⇒ "Compile" ⇒ "Structured Ladder/FBD/ST" ⇒ "Compile Condition1".
2. In "Function Output Setting", select the function(s) (PLS, PLF, and/or ALT) to be set.
  - If all check boxes are cleared, an error occurs when compiling programs.
  - If any of these check boxes are selected, errors and warnings are not displayed when compiling programs.

Example: Creating a program using the PLS output  
 <The check boxes are cleared>  
 The output is required to be retained at the label or device.

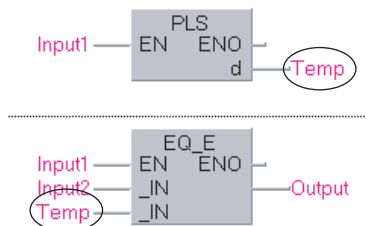

<The check box is selected>  
 The output can be connected directly to another input with a line.



9	SEARCHING FOR SPECIFIC POSITION
10	CONVERTING/COMPILING PROGRAMS
11	WRITING/READING DATA TO/FROM PROGRAMMABLE CONTROLLER CPU
12	MONITORING
13	USING USER LIBRARIES
14	SETTING OPTIONS
A	APPENDIX
I	INDEX

## 10.4.6 Using VAR\_OUTPUT for an argument of function block

Use VAR\_OUTPUT for an argument of function block in an ST program.

### Operating procedure

1. Select [Tool] ⇒ [Options] ⇒ "Compile" ⇒ "Structured Ladder/FBD/ST" ⇒ "Compile Condition1".
2. Select "Allow VAR\_OUTPUT at FB call (ST)".  
If this check box is cleared, an error occurs when compiling programs.

## 10.4.7 Assigning temporary arguments for arguments when calling function block

Assign temporary arguments for arguments (input, output, and input/output) when calling function block.

To retain the value in the function block and perform Online program change, change the settings to set the temporary value for the device connected to the function block output argument after executing the function block.

### Operating procedure

1. Select [Tool] ⇒ [Options] ⇒ "Compile" ⇒ "Structured Ladder/FBD/ST" ⇒ "Compile Condition1".
2. Select "Add temporary variables as arguments to use macrocode".

All programs need to be compiled after changing the option settings. (☞ Section 10.5.3)

### Point

#### ● Number of steps for compilation result and scan time for programmable controller

Since arguments are replaced to the temporary arguments according to each argument (input, output, and input/output) when calling function block, the number of steps for compilation result increases and the scan time for programmable controller is lengthened.

#### ● Target program types

The table below shows the combination of target program and function block.

Since the temporary variables are not added to each argument when calling the function block in other than the following situations, the values of arguments are not retained when the arguments of function block are changed by executing Online program change.

○: Applicable , ×: Not applicable

		Call destination function block		
		Ladder	Structured Ladder/ FBD	ST
Call source program/ function block	Ladder	×	×	×
	Structured Ladder/ FBD	×	○	○
	ST	×	×	×
	SFC	×	×	×



## 10.4.8 Assigning common devices to outputs of function with EN/ENO

Assign common devices to each function, when system devices are automatically assigned to outputs of function with EN/ENO while editing on the Structured Ladder/FBD/ST editor.

### Operating procedure

1. Select [Tool] ⇒ [Options] ⇒ "Compile" ⇒ "Structured Ladder/FBD/ST" ⇒ "Compile Condition3".
2. Clear "Automatically assign each system device to output of functions that use EN/ENO".

- If the check box is selected, the individual devices are assigned to each function.
- If the check box is cleared, the same device is assigned to the outputs.

Example: Devices automatically assigned to outputs of function with EN/ENO

<The check box is selected>

The individual devices are assigned.

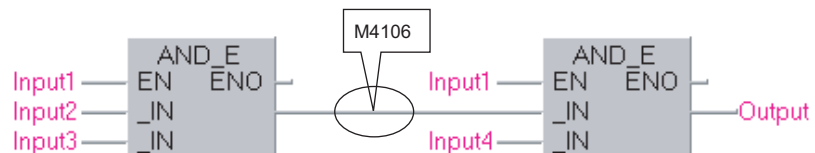
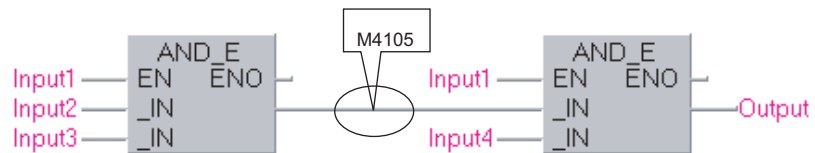

<The check box is cleared>

The same device is assigned.

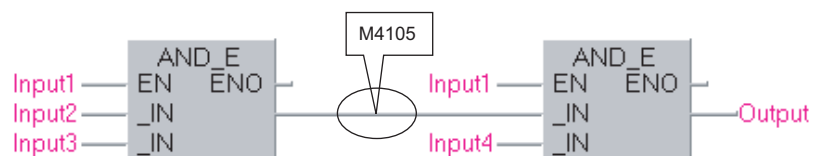
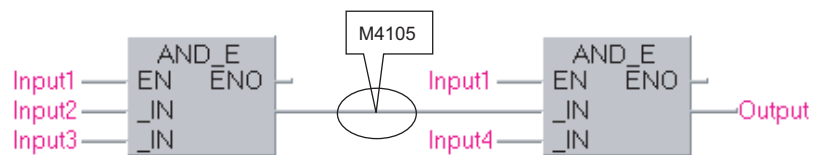

■ Considerations when the check box is cleared

Clear the check box of the option setting to save the number of automatically assigned devices to be used.

Considerations are taken into account when performing this operation. The following are the program examples which require considerations.

● Program examples which require considerations

Clear the check box of the option setting to assign the same devices to ① and ② as shown below. However, since the AND instruction without EN/ENO is executed without the execution condition, B9 may turn ON even when M3 and M4 are OFF.

M8190 is assigned to ①, M8188 is assigned to ② in the following program example.

<Example of ladder program>

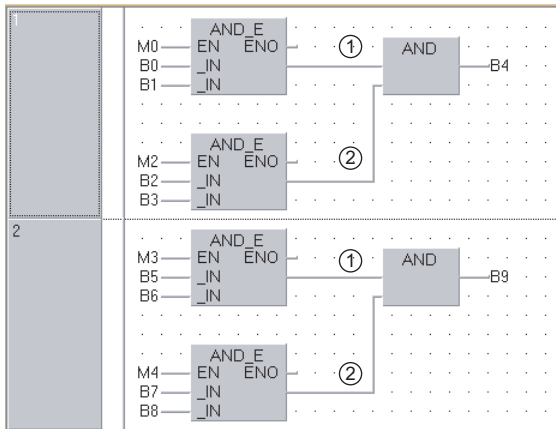

<Compilation result of ladder block 1>

Step	Compile Result
0	LD B0
1	AND B1
2	OUT M8187
3	LD M0
4	AND M8187
5	SET M8190
6	LD M0
7	ANI M8187
8	RST M8190
9	LD B2
10	AND B3
11	OUT M8186
12	LD M2
13	AND M8186
14	SET M8188
15	LD M2
16	ANI M8186
17	RST M8188
18	LD M8190
19	AND M8188
20	OUT B4

<Compilation result of ladder block 2>

Step	Compile Result
21	LD B5
22	AND B6
23	OUT M8187
24	LD M3
25	AND M8187
26	SET M8190
27	LD M3
28	ANI M8187
29	RST M8190
30	LD B7
31	AND B8
32	OUT M8186
33	LD M4
34	AND M8186
35	SET M8188
36	LD M4
37	ANI M8186
38	RST M8188
39	LD M8190
40	AND M8188
41	OUT B9

When M3 and M4 are OFF, the execution result is not stored on M8190, M8188.

B9 may turn ON even when M3 and M4 are OFF.

● Example of program which outputs the correct result

Create a program as indicated below to output the correct operation result to B9.

- Use instruction (AND\_E) with EN/ENO to output instruction.
- Regard logical AND of input (AND\_E)'s execution result as output's execution condition (EN).

<Example of ladder program>

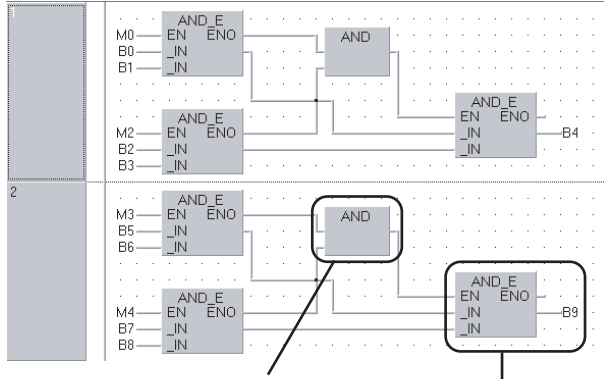

Regard logical AND of input (AND\_E)'s execution result as output's execution condition.

Use instruction (AND\_E) with EN/ENO.

<Compilation result of ladder block 1>

Step	Compile Result
0	LD B0
1	AND B1
2	OUT M8178
3	LD M0
4	AND M8178
5	SET M8182
6	LD M0
7	ANI M8178
8	RST M8182
9	LD B2
10	AND B3
11	OUT M8177
12	LD M2
13	AND M8177
14	SET M8180
15	LD M2
16	ANI M8177
17	RST M8180
18	LD M0
19	AND M2
20	OUT M8179
21	LD M8182
22	AND M8180
23	OUT M8176
24	LD M8179
25	AND M8176
26	SET B4
27	LD M8179
28	ANI M8176
29	RST B4

<Compilation result of ladder block 2>

Step	Compile Result
30	LD B5
31	AND B6
32	OUT M8178
33	LD M3
34	AND M8178
35	SET M8182
36	LD M3
37	ANI M8178
38	RST M8182
39	LD B7
40	AND B8
41	OUT M8177
42	LD M4
43	AND M8177
44	SET M8180
45	LD M4
46	ANI M8177
47	RST M8180
48	LD M3
49	AND M4
50	OUT M8179
51	LD M8182
52	AND M8180
53	LD M8179
54	AND M8176
55	SET B9
56	LD M8179
57	ANI M8176
58	ANI M8176
59	RST B9

Store logical AND of input (AND\_E)'s execution result on M8179.

Only when M3 and M4 are ON, the operation result is stored on B9.

SEARCHING FOR SPECIFIC POSITION	9
CONVERTING/COMPILING PROGRAMS	10
WRITING/READING DATA TO/FROM PROGRAMMABLE CONTROLLER CPU	11
MONITORING	12
USING USER LIBRARIES	13
SETTING OPTIONS	14
APPENDIX	A
INDEX	I

### 10.4.9 Retaining bit type outputs of functions

Retain bit type outputs of the target function(s).

#### Operating procedure

1. Select [Tool] ⇒ [Options] ⇒ "Compile" ⇒ "Structured Ladder/FBD/ST" ⇒ "Compile Condition2".
2. Select the function(s) to be set.
  - If all check boxes are cleared, bit type outputs of function(s) are not retained. (An operation equivalent to the OUT instruction).
  - If the check box(es) is selected, bit type outputs of the function(s) are retained. (An operation equivalent to the SET instruction).

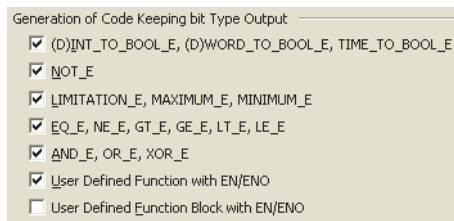

Example: Retaining the INT\_TO\_BOOL\_E output

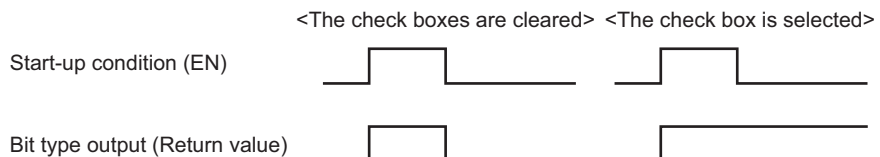
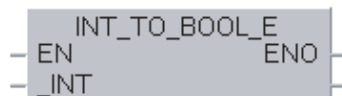

## 10.5 Compilation

Q CPU L CPU FX

By compilation operation, the labels are assigned to devices, and programs created in project with labels are converted to executable programs in a programmable controller CPU.

### ● Checking the compilation status

The compilation status can be checked on the Project view.

Data before compilation and data in which a compilation error occurs are displayed in red. After the compilation, the data other than compilation target are displayed in blue.

Uncompiled data can be displayed on the Project view by right-clicking on global label/POU/program file, and selecting [Open Uncompiled Data] from the shortcut menu.

Uncompiled data status is displayed on the Project view.

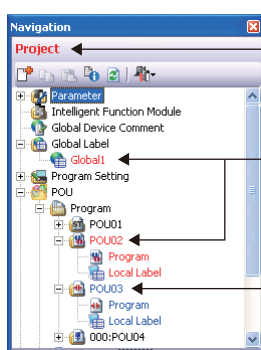

The characters on the title bar are displayed in red when the project is uncompiled.

Data before compilation and a data in which a compilation error occurs are displayed in red.

Data other than compilation target is displayed in blue.

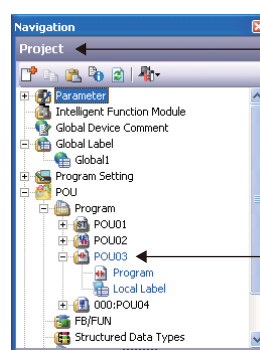

The characters on the title bar are displayed in white after compilation is completed.

Data other than compilation target is displayed in blue.

### 10.5.1 Compilation target data when compiling all programs

When compiling all programs, compilation target data are determined according to the registration/usage status of data type.

The following table shows the compilation target data.

○: Compiled, ×: Not compiled

Compilation target data type	Registration/usage status of compilation target data type	Compilation target when compiling all programs
Global label data	-	○
Program (program file)	Registered to any of the following programs.	
	• Initial program	
	• Scan program	
	• Wait program	○
	• Fixed interval program	
Task	Registered in the program file.	○
	Registered in the task.	○
Program	Not registered in the task.	×
	Declared in the label setting editor.	○
Function block	Not declared in the label setting editor.	×
	Used in the program.	○
Function	Not used in the program.	×
	Declared in the label setting editor.	○
Structure	Not declared in the label setting editor.	×

9

SEARCHING FOR SPECIFIC POSITION

10

CONVERTING/COMPILING PROGRAMS

11

WRITING/READING DATA TO/FROM PROGRAMMABLE CONTROLLER CPU

12

MONITORING

13

USING USER LIBRARIES

14

SETTING OPTIONS

A

APPENDIX

I

INDEX

## 10.5.2 Assigning devices

Assign the devices set with the "Device/Label Automatic-Assign Setting" function during compilation. In Structured Ladder/FBD and ST, create actual programs with temporary variable during compilation. Temporary variable is a device to retain the operation result of programs temporarily, and assign the device within the range set with the "Device/Label Automatic-Assign Setting" function.

Temporary variable is used for such as the following situations.

- Lines are branched in Structured Ladder/FBD
- Over 3 items of four arithmetic operations are used in ST
- Other situations which require retaining the operation result temporarily

Temporary variable can be checked by compilation result. (Section 6.2.7)

### ■ Assigning devices defined on the label setting editor to the labels

The following explains the device assignment to the labels defined on the label setting editor.

For global labels, only labels whose "Device"/"Address" are blank on the label setting editor can be assigned.

When both global labels and local labels are assigned, global labels are assigned to devices first, and then local labels are assigned to devices.

#### ● Assigning only one type of device automatically

Assign the devices in top down order on the label setting editor.

Devices are assigned in descending order on the screen (assigned from higher number of a device number) of device range set the "Device/Label Automatic-Assign Setting" function.

For pointer (P), devices are assigned in ascending order (assigned from lower number of a device number).

Example: <Device automatic-assign setting>

Set the following device range.

- D device: 8000 to 8191

<Label setting>

	Class	Label Name	Data Type
1	VAR	Label_A	Word[Signed]
2	VAR	Label_B	Word[Signed]
3	VAR	Label_C	FLOAT (Double Precision)
4	VAR	Label_D	FLOAT (Double Precision)

<Devices to be assigned to labels>

Definition order	Label name	Data type	Example of devices to be assigned
1	Label_A	Word (signed)	D8191
2	Label_B	Word (signed)	D8190
3	Label_C	Double-precision real	D8186
4	Label_D	Double-precision real	D8182

↓  
Descending order

### ● Assigning multiple types of device automatically (QCPU (Q mode)/LCPU)

Assign the devices in top down order on the label setting editor.

Devices are assigned in descending order (assigned from higher number of a device number) of device range set with the "Device/Label Automatic-Assign Setting" function.

When the number of devices is less than the number of devices required for one label, devices are assigned in descending order of the next device's device range. When the following label requires the devices which are within the above device range, the previous devices which are not assigned yet are assigned.

Example 1: <Device automatic-assign setting>

Set the following device range.

- D device: 8000 to 8002
- ZR device: 0 to 1023

<Label setting>

	Class	Label Name	Data Type
1	VAR	Label_A	Word(Signed)
2	VAR	Label_B	Word(Signed)
3	VAR	Label_C	FLOAT (Double Precision)
4	VAR	Label_D	FLOAT (Double Precision)

<Devices to be assigned to labels>

Definition order	Label name	Data type	Example of devices to be assigned
1	Label_A	Word (signed)	D8002
2	Label_B	Word (signed)	D8001
3	Label_C	Double-precision real	ZR1020*1
4	Label_D	Double-precision real	ZR1016

Descending order  
↓

\*1 : Since double-precision real requires four devices, one device of D8000 is not enough. Therefore, the next device ZR is assigned.

Example 2: <Device automatic-assign setting>

Set the following device range.

- D device: 8000 to 8002
- ZR device: 0 to 1023

<Label setting>

	Class	Label Name	Data Type
1	VAR	Label_A	Word(Signed)
2	VAR	Label_B	FLOAT (Double Precision)
3	VAR	Label_C	Word(Signed)
4	VAR	Label_D	FLOAT (Double Precision)

<Devices to be assigned to labels>

Definition order	Label name	Data type	Example of devices to be assigned
1	Label_A	Word (signed)	D8002
2	Label_B	Double-precision real	ZR1020*1
3	Label_C	Word (signed)	D8001*2
4	Label_D	Double-precision real	ZR1016*3

Descending order  
↓

\*1 : Since double-precision real requires four devices, two device of D8000 to D8001 are not enough. Therefore, the next device ZR is assigned.

\*2 : Since word (signed) requires one device, D8001 can be assigned. Therefore, return to the previous device (D device), and the device is assigned to the label.

\*3 : Since double-precision real requires four devices, one device of D8000 is not enough. Therefore, the next device ZR is assigned.

## ■ Assigning to temporary variable (automatically assigned device to other than label)

Assign a device to temporary variable.

### ● When the type of device to be assigned is one (QCPU (Q mode)/LCPU)

Devices are assigned in descending order (assigned from higher number of a device number) of device range set with the "Device/Label Automatic-Assign Setting" function in the same manner as the assignment to a label defined in a label setting editor.

### ● When the multiple types of devices are assigned automatically

Select one device to be assigned from devices set with the "Device/Label Automatic-Assign Setting" function with the order of ZR → R → W → D/B → M.

Multiple device types are not assigned to temporary variable.

Example 1: <Device automatic-assign setting>  
Set the following device range.

- D device: 8000 to 8191
- ZR device: 0 to 1023

<Device to be assigned>  
Assign ZR for temporary variable

Example 2: <Device automatic-assign setting>  
Set the following device range.

- D device: 8000 to 8191
- W device: 0 to 1023

<Device to be assigned>  
Assign W for temporary variable

## ■ Checking usage of automatically assigned devices

The usage of devices within the range set on the Device/Label Automatic-Assign Setting screen can be checked when compiling programs.

After programs are compiled, the usage of device points and device assignment range are displayed on the Output window.

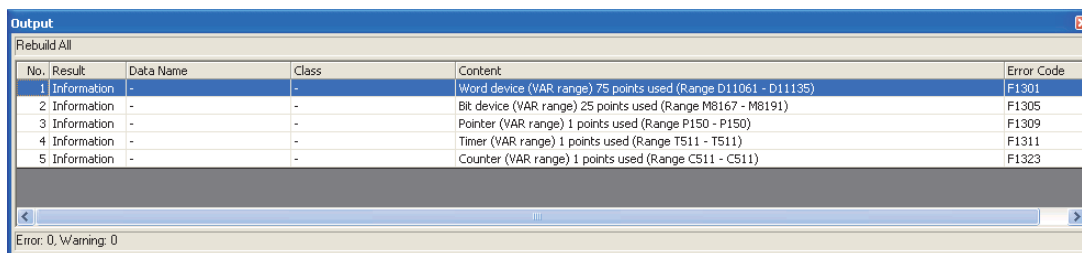

No.	Result	Data Name	Class	Content	Error Code
1	Information	-	-	Word device (VAR range) 75 points used (Range D11061 - D11135)	F1301
2	Information	-	-	Bit device (VAR range) 25 points used (Range M8167 - M8191)	F1305
3	Information	-	-	Pointer (VAR range) 1 points used (Range P150 - P150)	F1309
4	Information	-	-	Timer (VAR range) 1 points used (Range T511 - T511)	F1311
5	Information	-	-	Counter (VAR range) 1 points used (Range C511 - C511)	F1323

Error: 0, Warning: 0

### Point

#### ● Displaying usage of device assignment range

Assigned devices from the minimum number to the maximum number are displayed for the usage of device assignment range.

When [Build] is executed repeatedly after changing/deleting labels, the devices which are not used are included in the usage points.

Execute [Rebuild All] to display the correct usage of the device assignment range.



### 10.5.3 Considerations of Compilation

#### ● When the multiple types of devices are assigned automatically (QCPU (Q mode)/LCPU)

Since the devices assigned once cannot be used, if a program or label is changed and executed "Build" repeatedly, the number of used devices is increased and the number of assignable devices is decreased. Execute "Rebuild All".

When D, W, R, ZR are selected as automatically assigned device concurrently, devices are assigned from D, W. If the number of D, W is not enough, devices are assigned from R, ZR.

Note that since the operation processing times of D, W, and R differ from that of ZR, the control timing may change depending on the program content.

For details of operation processing time, refer to the following manual.

☞ MELSEC-Q/L Structured Programming Manual (Common Instructions)

#### ● When ZR is added to automatically assigned device after compilation (QCPU (Q mode)/LCPU)

Temporary variable assigns only one type of devices, however, when ZR device is added to automatically assigned device after compilation, ZR device is assigned by recompilation.

Operation processing time may differ depending on the program content.

Increase the device range other than ZR to avoid the change of operation processing time.

#### ● The "Device/Label Automatic-Assign Setting" function

Devices in the range set with the "Device/Label Automatic-Assign Setting" function (automatically assigned devices) cannot be used in the program.

If automatically assigned devices are used in a program, a compilation error occurs.

(For the "Device/Label Automatic-Assign Setting" function ☞ Section 5.8 )

#### ● When array labels are used

When devices/labels are used for indexes in array labels, the compilation result is created with the devices shown below.

Note that the device values may be overwritten when the following devices are used in user programs.

- Basic model QCPU, High Performance model QCPU: Z0, Z1
- Universal model QCPU, LCPU: Z16 to 19
- FXCPU: Z0, V0

#### ● Projects which use devices/labels for indexes in structure array labels

The accessible number of array elements differs between GX Works2 Version 1.98C or earlier and GX Works2 Version 1.492N or later according to the programmable controller type and the index modification.

Review the program where over 65,536 array elements are accessed because the program operation may be changed if the project created in GX Works2 Version 1.98C or earlier is compiled.

#### ● Checking labels used for arguments of instruction

The label checking method differs according to the programming language.

- For Ladder Diagram and Sequential Function Chart (Zoom), check if the devices are applicable to the instruction.
- For Structured Ladder/FBD and Structured Text, check if the data types are applicable to the instruction.

#### ● Canceling the compilation

The compilation is canceled in a program file unit. Therefore, even when the  button is clicked during the compilation, the compilation will not be canceled until the compilation of one program file is completed.

Note that a large-scale program file with multiple functions/function blocks requires a longer time to cancel the compilation.

### ● Assigning devices to labels when compiling all programs

All programs need to be compiled when the following operations are performed.

- Changing the following PLC parameters\*1
  - "Common Pointer No." and "Timer Limit Setting" on the <<PLC System>> tab
  - "File Register" and "File for Local Device" on the <<PLC File>> tab
  - Settings on the <<Device>> tab
- Changing the following option settings
  - "Default Length of String Data Type" in "Label Setting Editor"
  - Settings in "Compile"
- Changing automatically assigned devices
- Updating instructions and application functions when opening Structured project.
- Changing PLC type
- Changing project type
- Reading data from programmable controller CPU (except for when reading symbolic information and parameters at the same time)
- Reading data written to the programmable controller CPU by GX Developer or GX IEC Developer
- Using Open Other Project function

When all programs are compiled, devices are reassigned to labels in all POU's. If all the compiled programs are written to the programmable controller CPU and run as they are, the programs may be processed with the device values set before the program change.

After compiling all programs, clear the device values set before the program change by the following procedure.

Note that, by setting the following option, device values in the range set in the "Device/Label Automatic-Assign Setting" function can be automatically cleared to 0 after writing programs to the programmable controller CPU.

- [Tool] ⇒ [Options] ⇒ "PLC Read/Write" ⇒ "When writing to PLC after a Rebuild All operation, clear the device ranges set in the Device/Label Auto-Assign setting to 0."

\*1 : QCPU (Q mode)/LCPU only

- **QCPU (Q mode)/LCPU**

#### Operation

1. **Switch the programmable controller CPU to STOP.**
2. **Select [Online] ⇒ [Write to PLC], and write programs to the programmable controller CPU.**
3. **Switch the programmable controller CPU to RESET.**  
It can also be reset by selecting [Compile] ⇒ [Remote Operation].
4. **Select [Online] ⇒ [PLC Memory Operation] ⇒ [Clear PLC Memory] to clear the memories.**  
If VAR\_RETAIN is set with the "Device/Label Automatic-Assign Setting" function, clear all device memories including latches.  
If file registers are set with the "Device/Label Automatic-Assign Setting" function, clear all file registers.

- **FXCPU**

#### Operation

1. **Switch the programmable controller CPU to STOP.**
2. **Select [Online] ⇒ [Write to PLC], and write programs to the programmable controller CPU.**

**3. Select [Online] ⇒ [PLC Memory Operation] ⇒ [Clear PLC Memory] to clear the device memories.**

The remote RUN function when writing data to programmable controller CPU after compiling all programs can be disabled by setting the following option. Select "Turn PLC to STOP at time of PLC write after executing Rebuild All and do not execute remote RUN" under [Tool] ⇒ [Options] ⇒ "PLC Read/Write".

● **Compiling programs when adding/changing labels**

When programs are compiled after adding/changing labels, devices are assigned only for added/changed labels. Device assignments of labels which are not added or changed do not change. Since previous device values may remain among the devices reassigned to labels, clear the previous device values by the following procedure when adding/changing labels.

**Operation**

1. **Add/change labels only.**  
(Do not edit the programs.)
2. **Select [Compile] ⇒ [Build], and compile the programs.**
3. **Register added/changed labels to the Watch window and clear the current values to 0.**
4. **Edit the programs and select [Compile] ⇒ [Online Program Change].**

● **Modification of global labels and functions/function blocks**

If global labels and/or functions/function blocks are modified, multiple program blocks become the compile targets. Write all program files of the compile targets to the programmable controller CPU to apply the modifications.

Example: Compiling programs after modifying Function 1 in the following program configuration. Program blocks 3 and 4 are compiled and the program files MAIN and SUB1 are modified.

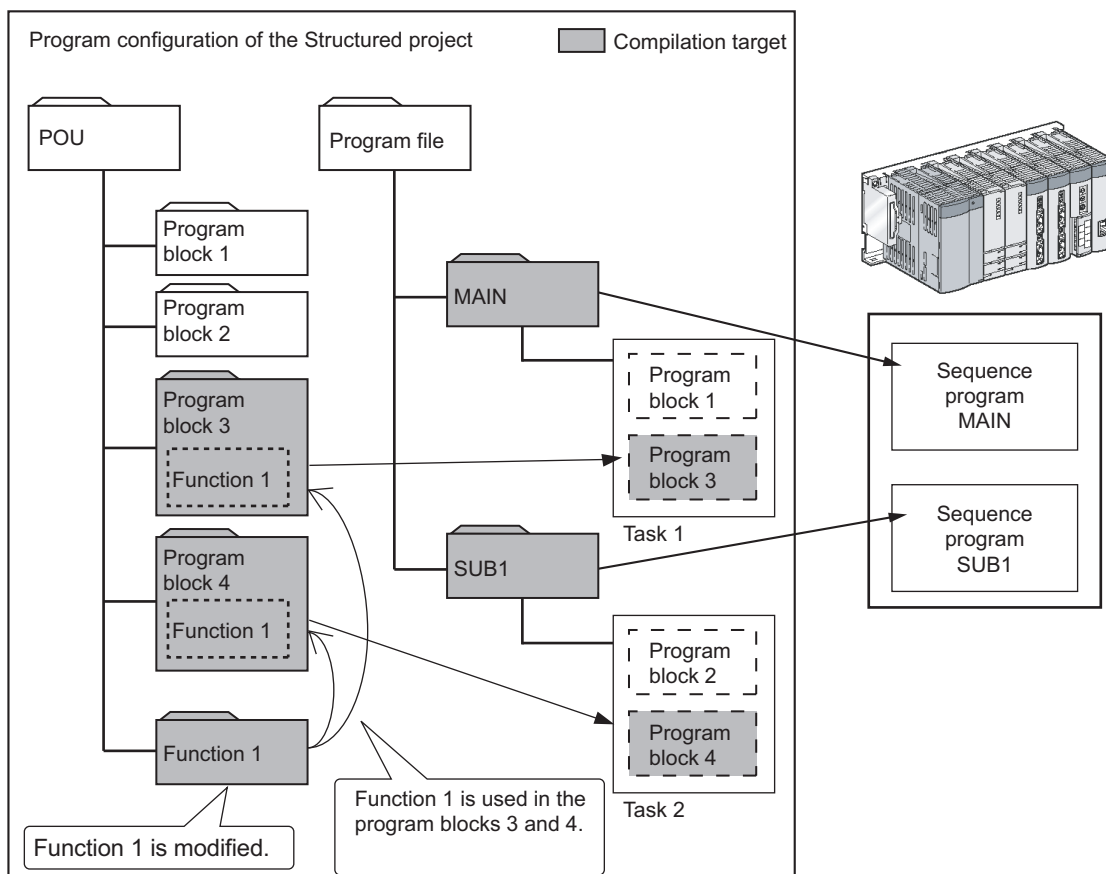

● Arguments of function/function block

- Data cannot be written to input arguments (VAR\_INPUT) of function/function block. If data are written to input arguments, a compilation error occurs.
- When utilizing function blocks, constants can be used for the input side of I/O argument (VAR\_IN\_OUT). However, depending on the combination of the programming languages of call source program/ function block and call destination function block, a compilation error may occur. The applicability of the compilation is as follows:

○: Applicable, ×: Not applicable

Programming language of call source program/ function block*1	Programming language of call destination function block	I/O argument to which constant is input		
		Data type	Do not use I/O argument for output side in function block	Use I/O argument for output side in function block
Ladder, SFC	Ladder	Bit type	○	○
		Other than bit type	×	×
	Structured Ladder/FBD, ST	Bit type	○	○
		Other than bit type	×	×
Structured Ladder/FBD, ST	Ladder	Bit type	○	○
		Other than bit type	○	×
	Structured Ladder/FBD, ST	Bit type	○	×
		Other than bit type	○	×

\*1 : When calling the function blocks created in other programming language, refer to the following section.  
 ➤ Section 4.4.1 "■ Using function blocks created in other programming languages"

- The structure with no elements cannot be specified as arguments of function/function block.

● Compiling Structured Ladder/FBD/ST programs

The code is not created when the program as shown below is compiled in the Structured Ladder/FBD or ST program.

Example) The same device is used for a contact and coil

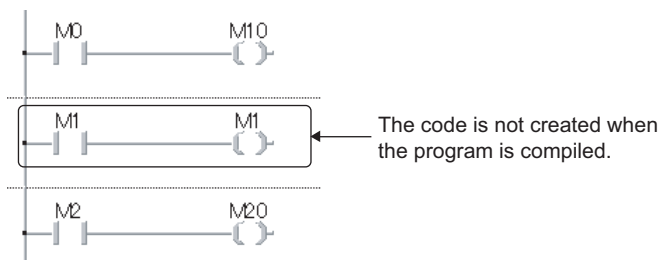

# 10.6 Checking for Errors and Warnings

Q CPU L CPU FX

When the program check or the compilation is executed, the target programs and label settings are checked and the results are displayed on the Output window. The following explains how to check the errors displayed on the Output window.

## Screen display

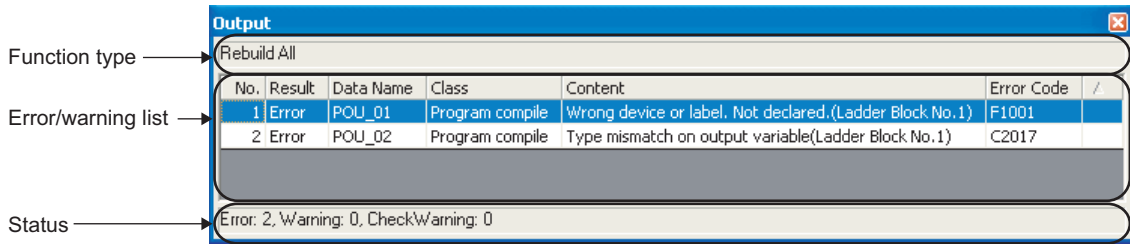

## Display contents

Item	Content
Function type	Display the name of the executed function.
Error/warning list	-
Result	Display the check results. Display "Error" and "Warning". Display "Check Warning" for the duplicated coil check/ladder program check/consistency check warnings.
Data Name	Display data names with errors and warnings.
Class	Display check types such as the compilation and program check.
Content	Display descriptions of errors and warnings.
Error Code	Display error code numbers.
Status	Display the total number of errors and warnings.

9 SEARCHING FOR SPECIFIC POSITION

10 CONVERTING/COMPILING PROGRAMS

11 WRITING/READING DATA TO/FROM PROGRAMMABLE CONTROLLER CPU

12 MONITORING

13 USING USER LIBRARIES

14 SETTING OPTIONS

A APPENDIX

I INDEX

## 10.6.1 Correcting errors and warnings

Check and correct errors/warnings.

### Operating procedure

#### 1. Double-click the error/warning message displayed on the Output window.

The corresponding error location in the program is displayed.

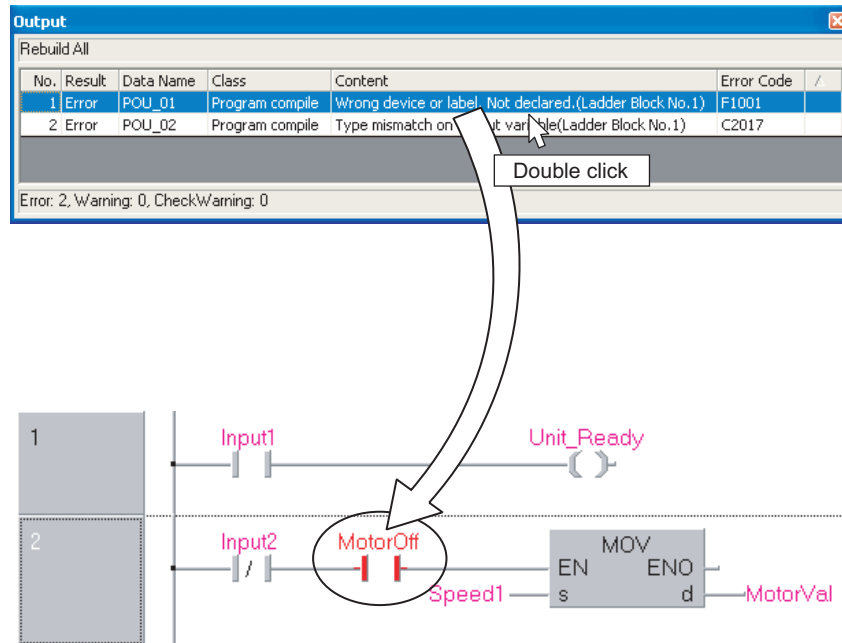

#### 2. Check the corresponding error location and correct the error as instructed by the error/warning message.



# 11 WRITING/READING DATA TO/FROM PROGRAMMABLE CONTROLLER CPU

This chapter explains how to write/read sequence programs to/from the programmable controller CPU or memory card.

For the overview of the data write/read operation, refer to the following manual.

 GX Works2 Version 1 Operating Manual (Common)

11.1	Writing/Reading Data to/from Programmable Controller CPU	11 - 2
------	--	--------

9	SEARCHING FOR SPECIFIC POSITION
10	CONVERTING/COMPILING PROGRAMS
11	WRITING/READING DATA TO/FROM PROGRAMMABLE CONTROLLER CPU
12	MONITORING
13	USING USER LIBRARIES
14	SETTING OPTIONS
A	APPENDIX
I	INDEX

## 11.1 Writing/Reading Data to/from Programmable Controller CPU

Q CPU L CPU FX

This section explains how to write the Structured project data to the programmable controller CPU or memory card, and how to read the data from the programmable controller CPU or memory card to the project.

For FXCPU projects with labels, created project data can be read from FX3U/FX3UC version 3.00 or later only.

### Screen display

Select [Online] ⇒ [Write to PLC] (  )/[Read from PLC] (  ).

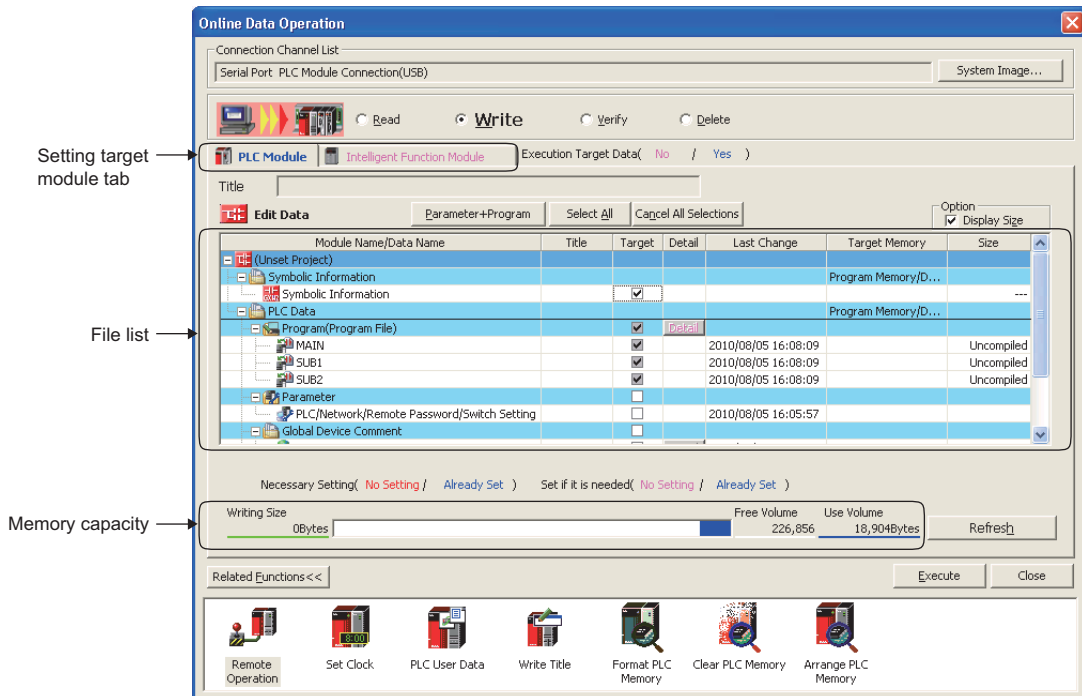

For QCPU (Q mode)/LCPU/FXCPU (FX3U/FX3UC version 3.00 or later), symbolic information is displayed on the file list.







## Operating procedure

### 1. Set the items on the screen.

Item	Description
Connection Channel List	Display the information on the set connection destination.
Setting target module tab	Switch the setting target module. If the target data of write/read exists, the color of the tab name is displayed in blue.
PLC Module	Set to write the data to the programmable controller CPU.
Intelligent Function Module*1	Set to write the data of the intelligent function module to buffer memory/flash ROM of the intelligent function module. ☞ GX Works2 Version 1 Operating Manual (Common)
Title*1	Display the title of the target memory by clicking the  button.
Option*1	-
Display Size	Select this to display "Size" and memory capacity in the file list.
File list	-
Target	Select the data to be written/read.
Target Memory*1	Select the memory from the list  by clicking the cell under "Target Memory". For details of the memory card application, refer to the following manual. ☞ User's Manual (Hardware Design, Maintenance and Inspection) of the CPU module to be used
Memory capacity*2	-
Writing Size	Display the total size of written data selected in "Target".
Free Volume	Display the free space volume of the target memory.
Use Volume	Display the used space volume of the target memory.

\*1 : Not supported by FXCPU.

\*2 : For FXCPU, program size and symbolic information data size are displayed when executing the Write to PLC function. Symbolic information size is displayed on the screen for projects with labels of FX3U/FX3UC version 3.00 or later only.

When a program (program file), device comment, or device memory is selected, the range can be set by clicking the  /  button.

When reading data from the programmable controller CPU, and the device memory is selected, the detailed settings are required.

For details, refer to the following manual.

☞ GX Works2 Version 1 Operating Manual (Common)

### 2. Click the button.

When the Write to PLC function is executed, the specified data are written to the target memory. When the Read from PLC function is executed, the specified data are read from the target memory.

9

SEARCHING FOR SPECIFIC POSITION

10

CONVERTING/COMPILING PROGRAMS

11

WRITING/READING DATA TO/FROM PROGRAMMABLE CONTROLLER CPU

12

MONITORING

13

USING USER LIBRARIES

14

SETTING OPTIONS

A

APPENDIX

I

INDEX

## Screen button

- **System Image...**  
Displays the illustration of the connection channel list.
- **Parameter + Program**  
Selects the parameters and all programs displayed on the list.
- **Select all**  
Selects all data displayed on the list.
- **Cancel all selections**  
Cancels the selection status of all data displayed on the list.
- **Related Functions>>** / **Related Functions<<**  
Switches display/hide of the Related functions button.  
For details of the related functions, refer to the following manual.  
 GX Works2 Version 1 Operating Manual (Common)
- **Acquire Symbolic Information Project Name** **(Read from PLC, Delete PLC Data only)**  
Displays the project name of the symbolic information on the Title/Project Name column.
- **Refresh**  
Updates the file list on the Online Data Operation screen.  
For QCPU (Q mode)/LCPUs, updates writing size, free space volume, and used space volume.  
When multiple personal computers are connected to the programmable controller CPU, update the target memory before reading data from the programmable controller CPU.

■ **Symbolic information**

The symbolic information is data that store the program configuration such as structures and labels. To restore these data included in the symbolic information when reading a program from the programmable controller CPU, write/read the symbolic information to/from the programmable controller CPU.

Data such as structures and labels included in the symbolic information cannot be restored if only sequence programs are read. (Data are treated as ladder programs in Structured projects.)

The following table shows the program data included in the symbolic information.

Item	Included data
Symbolic information	Global label
	Program setting
	Task
	POU
	Program
	Local label
	Function block
	Function
	Structure
	User library

**Point**

● **Compile status when the symbolic information is read**

- When the symbolic information and parameters are read simultaneously, and the data in the symbolic information match with parameters and programs (program files) in the programmable controller CPU, the read data are in compiled status. When only the symbolic information is read, the read data are in uncompiled status.
- When the symbolic information of GX Developer or GX IEC Developer is read, the read data are in uncompiled status. Compile the program again after executing the Read from PLC function.

● **Considerations for reading symbolic information**

For the considerations for reading label programs (symbolic information) of the existing application using GX Works2, or reading label programs (symbolic information) of GX Works2 using the existing application, refer to the following manual.

(📖 GX Works2 Version 1 Operating Manual (Common))

● **For FXCPU**

- The symbolic information data can be read from/written to the programmable controller CPU in FX3U and FX3UC version 3.00 or later only.
- When a memory cassette to which the symbolic information has been written is used on an FXCPU other than FX3U/FX3UC version 3.00 or later, the symbolic information may be corrupted.

● **Saving project automatically after writing data to programmable controller CPU**

A project can be saved automatically after writing data to the programmable controller CPU by setting the option. Select "Save project after writing to PLC" under [Tool] ⇒ [Options] ⇒ "Project" ⇒ "Automatic Save".

SEARCHING FOR SPECIFIC POSITION	9
CONVERTING/COMPILING PROGRAMS	10
WRITING/READING DATA TO/FROM PROGRAMMABLE CONTROLLER CPU	11
MONITORING	12
USING USER LIBRARIES	13
SETTING OPTIONS	14
APPENDIX	A
INDEX	I





# 12 MONITORING

This chapter explains how to monitor the program execution status of the programmable controller CPU using the program editor.

For the overview of monitoring, refer to the following manual.

☞ GX Works2 Version 1 Operating Manual (Common)

12.1	Starting and Stopping Monitoring Programs	12 - 2
12.2	Starting and Stopping Monitoring Function Blocks	12 - 4
12.3	Changing Operating Conditions of Monitoring	12 - 5
12.4	Monitoring Programs on ST Editor	12 - 7
12.5	Monitoring Programs in Structured Ladder/FBD Editor	12 - 9
12.6	Setting Monitoring Conditions	12 - 11

SEARCHING FOR SPECIFIC POSITION	9
CONVERTING/COMPILING PROGRAMS	10
WRITING/READING DATA TO/FROM PROGRAMMABLE CONTROLLER CPU	11
MONITORING	12
USING USER LIBRARIES	13
SETTING OPTIONS	14
APPENDIX	A
INDEX	I

## 12.1 Starting and Stopping Monitoring Programs

Q CPU L CPU FX

This section explains how to monitor a program on the program editor.  
Open the program editor to be monitored in advance.

### 12.1.1 Starting monitoring programs

Start monitoring the program.

#### Operating procedure

- Select [Online] ⇒ [Monitor] ⇒ [Start Monitoring] (  ).  
The monitoring starts.

#### ■ Verifying the program with the program on the programmable controller CPU before starting the monitoring

Set whether to verify the program with the program on the programmable controller CPU before starting the monitoring of the Structured Ladder/FBD editor or the ST editor.

#### Operating procedure

- Select "Always Verify with PLC"/"Not Always Verify with PLC"/"Confirm whether to Verify with PLC" under [Tool] ⇒ [Options] ⇒ "Monitor" ⇒ "Structured Ladder/FBD/ST"\*1.
  - When "Always Verify with PLC" is selected, the program is verified with the program on the programmable controller CPU before starting the monitoring.  
If the programs match, the monitoring starts.  
If the programs do not match, the following confirmation message is displayed.

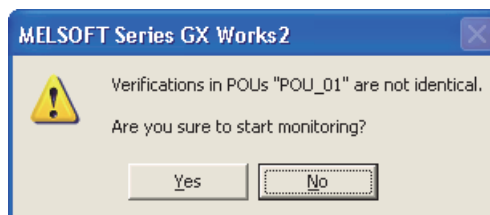

- When "Not Always Verify with PLC" is selected, the monitoring starts without verifying programs.
  - When "Confirm whether to Verify with PLC" is selected, the screen for selecting whether to verify programs before starting the monitoring.
- \*1 : For ST programs of Simple project (with labels), select the following.  
[Tool] ⇒ [Options] ⇒ "Monitor" ⇒ "ST"

**Point**● **Verification results**

This function verifies the instructions and the number of steps of the program with those of the program on the programmable controller CPU.

For this reason, the programs match even when any of the following modifications is performed in the program.

- Changing comments or layouts of Structured Ladder/FBD program
- Inserting blank rows or blank ladder blocks

If any of the following operations is performed, the programs may not match even when the program and the program on the programmable controller are the same.

- Compiling all programs
- Changing the setting position of the POU on the Task Setting screen
- Editing the POU in the program file as same as the one for the program to be monitored.

● **Function block programs**

When verifying function blocks with "Use Macrocode" is selected on the Property screen, the program in which the function blocks are utilized is verified.

Therefore, if the program is changed, the programs do not match even when the function block program is not changed.

● **Functions/function blocks used at more than two locations in the program**

Only the first function/function blocks used in the program are verified.

## 12.1.2 Stopping monitoring programs

Stop monitoring the program.

### Operating procedure

- **Select [Online] ⇒ [Monitor] ⇒ [Stop Monitoring] (  ).**

The monitoring stops.

**Point**● **Changing current values**

During monitoring, bit devices can be forced ON/OFF, and the current values of devices, buffer memories, and labels can be changed.

For forcing bit devices ON/OFF and changing current values, refer to the following manual.

 GX Works2 Version 1 Operating Manual (Common)

● **Monitoring buffer memory and link direct device**

To monitor the ON/OFF status of the buffer memory and link direct device (example: U0\G0.1), select [Tool] ⇒ [Options] ⇒ "Monitor" ⇒ "Structured Ladder/FBD/ST" ⇒ "Operational Setting" and select "Monitor buffer memory and link direct device".

● **Monitoring labels whose classes are set as a constant type**

For labels whose classes are set as VAR\_GLOBAL\_CONSTANT, VAR\_CONSTANT, the values are not displayed during monitoring.

To check the values, select "Constant Value" under [Tool] ⇒ [Options] ⇒ "Program Editor" ⇒ "Structured Ladder/FBD/ST" ⇒ "Tool Hint" ⇒ "Tool Hint Display Items", and check with tooltip.

9

SEARCHING FOR  
SPECIFIC  
POSITION

10

CONVERTING/  
COMPILING  
PROGRAMS

11

WRITING/READING DATA  
TO/FROM PROGRAMMABLE  
CONTROLLER CPU

12

MONITORING

13

USING USER  
LIBRARIES

14

SETTING OPTIONS

A

APPENDIX

I

INDEX

## 12.2 Starting and Stopping Monitoring Function Blocks

Q CPU L CPU FX

This section explains how to monitor function block programs.  
Open the function block program to be monitored in advance.

### ■ Starting monitoring function blocks



Start monitoring the function block.

#### Operating procedure

1. Select [Online] ⇒ [Monitor] ⇒ [Change Instance (Function Block)].

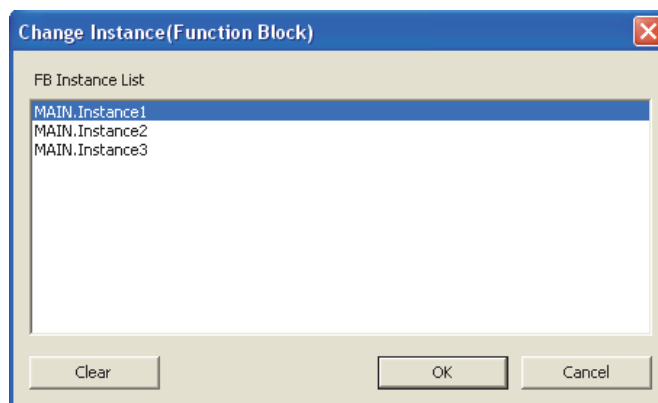
The Change Instance (Function Block) screen is displayed.

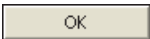

2. Select the FB instance to be monitored.
3. Click the  button.
4. Select [Online] ⇒ [Monitor] ⇒ [Start Monitoring] (  ).

The monitoring starts.

The display and executable operations during monitoring are the same as those of the program monitoring.

#### Screen button

- 

Clears the selected status of the FB instance and stops monitoring.

### ■ Stopping monitoring function blocks

Stop monitoring the function block.

#### Operating procedure

- Select [Online] ⇒ [Monitor] ⇒ [Stop Monitoring] (  ).  
The monitoring stops.



## 12.3 Changing Operating Conditions of Monitoring

Q CPU L CPU FX

This section explains how to change the operating conditions of monitoring.

### 12.3.1 Changing current value display format (decimal/hexadecimal) of word type variable

Change the current value display format of word and double word type variable displayed during monitoring.

#### ■ Changing display format during monitoring

Change the current value display format of word and double word type variable during monitoring.

##### Operating procedure

- Select [Online] ⇒ [Monitor] ⇒ [Change Value Format (Decimal)] / [Change Value Format (Hexadecimal)].

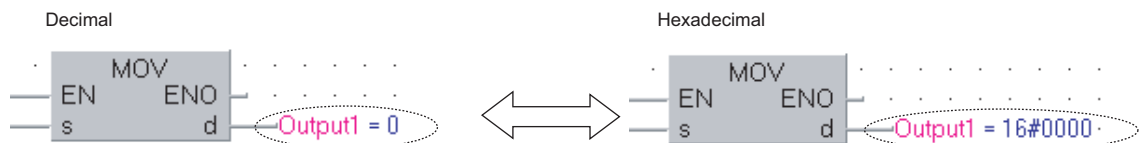

#### ■ Changing display format before starting monitoring

Change the current value display format by setting the option. The monitoring starts with the set display format.

##### Operating procedure

- Select [Tool] ⇒ [Options] ⇒ "Monitor" ⇒ "Structured Ladder/FBD/ST" ⇒ "Display Format of Monitoring Value" ⇒ "Decimal"/"Hexadecimal".

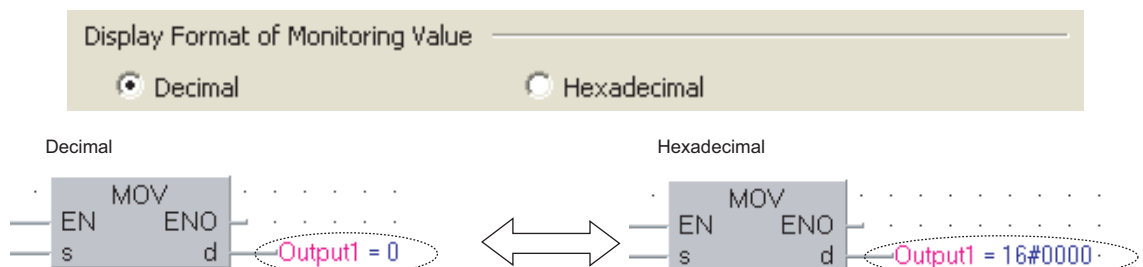

SEARCHING FOR SPECIFIC POSITION	9
CONVERTING/COMPILING PROGRAMS	10
WRITING/READING DATA TO/FROM PROGRAMMABLE CONTROLLER CPU	11
MONITORING	12
USING USER LIBRARIES	13
SETTING OPTIONS	14
APPENDIX	A
INDEX	I

### 12.3.2 Setting the number of displaying characters for character strings

---

Set the number of displaying characters for the monitoring result of character strings by setting the option on the Structured Ladder/FBD and ST editors.

#### Operating procedure

1. Select [Tool] ⇒ [Options] ⇒ "Monitor" ⇒ "Structured Ladder/FBD/ST" ⇒ "Character String Monitor Setting".
2. Set the number of displaying characters within the range from 2 to 50.

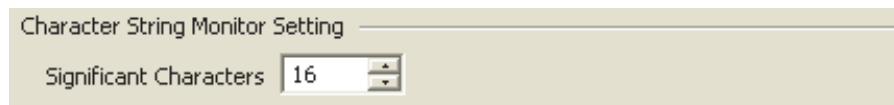

## 12.4 Monitoring Programs on ST Editor

Q CPU L CPU FX

This section explains the display of the ST editor at the monitoring.

### Screen display

Select [Online] ⇒ [Monitor] ⇒ [Start Monitoring].

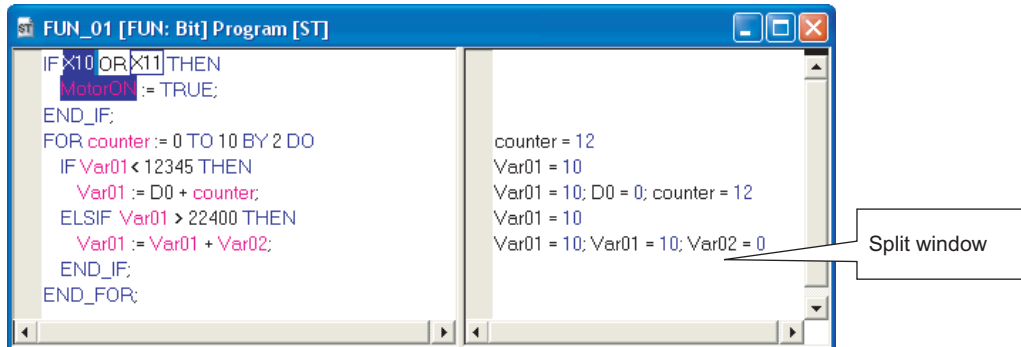

Select [Online] ⇒ [Monitor] ⇒ [Start monitor (bit type only)].

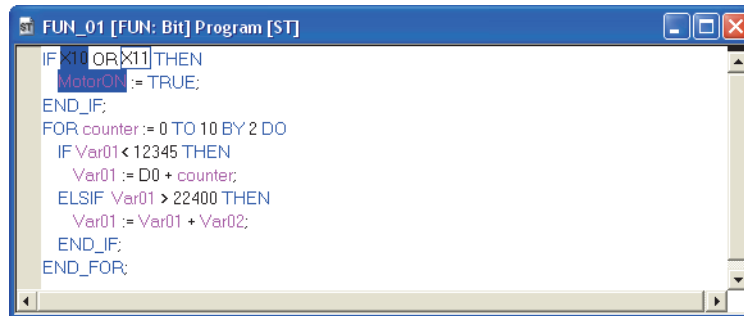

### ■ Monitoring labels other than bit type labels and word devices

The monitoring values of labels other than bit type labels and word devices are displayed on the right side of the split window.

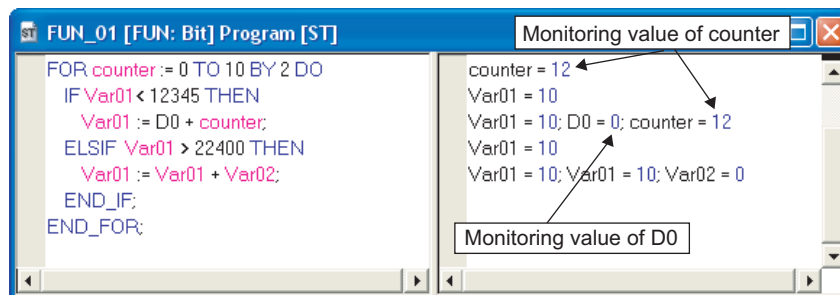

9

SEARCHING FOR  
SPECIFIC  
POSITION

10

CONVERTING/  
COMPILING  
PROGRAMS

11

WRITING READING DATA  
TO/FROM PROGRAMMABLE  
CONTROLLER CPU

12

MONITORING

13

USING USER  
LIBRARIES

14

SETTING OPTIONS

A

APPENDIX

I

INDEX

## ■ Monitoring bit type labels and bit devices

The following shows the display of bit type labels and bit devices at the monitoring.

<p>&lt;FALSE&gt;</p> <pre>IF X10 OR X11 THEN   MotorOn := TRUE; END_IF;</pre>	<p>&lt;TRUE&gt;</p> <pre>IF X10 OR X11 THEN   MotorOn := TRUE; END_IF;</pre>
---	--

### Point

#### ● Displaying monitoring values

When the labels are used for array element, or when the elements are not specified for array or structure, the monitoring values are not displayed correctly. The monitoring values on tooltip are not displayed correctly either. Monitoring values of each element for array or structure can be checked on the Watch window.

```
COS([Input],ArrayIn[index],ArrayOut| index = 0; ArrayOut[0] = 0.0
```

# 12.5 Monitoring Programs in Structured Ladder/FBD Editor

Q CPU L CPU FX

This section explains the display of the Structured Ladder/FBD editor at the monitoring.

## Screen display

Select [Online] ⇒ [Monitor] ⇒ [Start Monitoring].

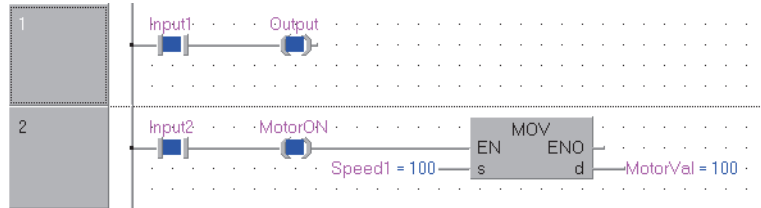

### Monitoring contacts and coils

The following shows the display of contacts and coils at the monitoring.

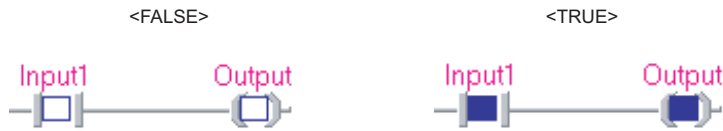

### Monitoring bit type labels and bit devices

The following shows the display of bit type labels and bit devices at the monitoring.

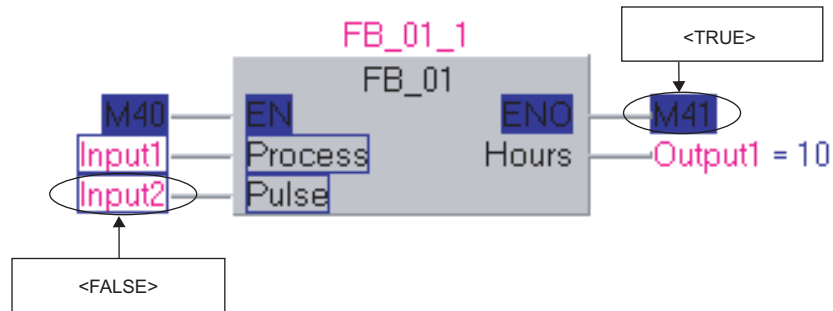

9 SEARCHING FOR SPECIFIC POSITION

10 CONVERTING/COMPILING PROGRAMS

11 WRITING/READING DATA TO/FROM PROGRAMMABLE CONTROLLER CPU

12 MONITORING

13 USING USER LIBRARIES

14 SETTING OPTIONS

A APPENDIX

I INDEX

### ■ Monitoring labels other than bit type labels and word devices

The monitoring values of labels other than bit type labels and word devices are displayed to the right of the corresponding labels or devices.

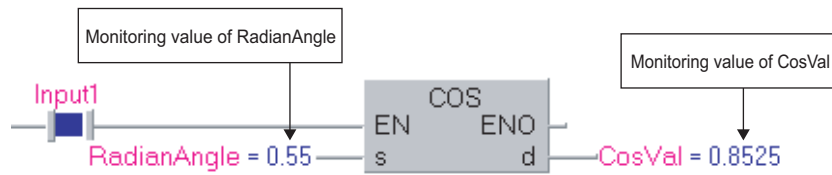

**Point**

● **Displaying monitoring values**

- Monitoring values of FB I/O arguments can be checked with the tooltip. For the display method of the tooltip, refer to Section 6.2.8.

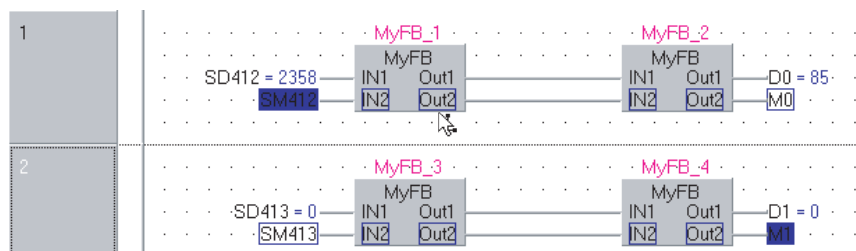

- When the labels are used for array element, or when the elements are not specified for array or structure, the monitoring values are not displayed. The monitoring values on tooltip are not displayed either. In this case, check monitoring values of array or structure on the Watch window.

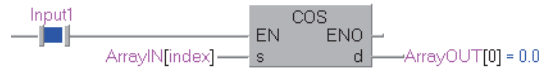

# 12.6 Setting Monitoring Conditions



\*1 : Not supported by Basic model QCPU, Q00UJ, Q00U, Q01U

Set a monitoring condition of Structured Ladder/FBD and ST editors.  
Monitoring starts when the specified condition is satisfied.

## Operating procedure

1. Select [Online] ⇒ [Monitor] ⇒ [Monitor Condition Setting] while the program is being monitored.

The Monitor Conditions Setting screen is displayed.

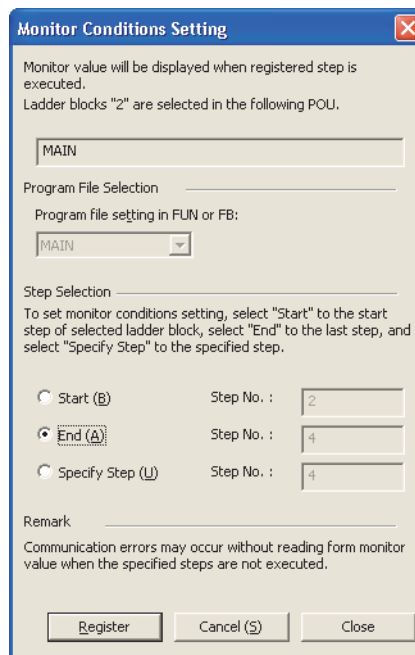

2. Set the items on the screen.

Item	Description
Program File Selection	Select the POU to be set the monitoring condition when a function used in the two or more POUs, or an FB instance declared in a global label exists.
Step Selection	–
Start	Select this to set the condition with the start of the selection range.
End	Select this to set the condition with the end of the selection range.
Specify Step	Select this to set the step number to be specified.

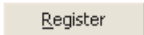
3. Click the  button.

The monitoring condition is registered and the monitoring stops.  
The monitoring starts when the specified condition is satisfied.

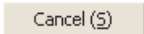
Click the  button before closing the Monitor Condition Setting screen.

## Screen button

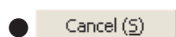

Cancels the registered condition.

9 SEARCHING FOR SPECIFIC POSITION

10 CONVERTING/COMPILING PROGRAMS

11 WRITING/READING DATA TO/FROM PROGRAMMABLE CONTROLLER CPU

12 MONITORING



13 USING USER LIBRARIES

14 SETTING OPTIONS

A APPENDIX

I INDEX

**Point****● Monitoring condition setting**

- The step number set for monitoring condition is the one displayed on the compilation result.
  - A communication error may occur if the step specified when selecting start or end is not executed.  
When an error occurs, set the step number for "Specify Step" after checking the compilation result.
  - When ST control syntax is used, the start number may be larger than the end number.
  - Since the function block where "Use Macrocode" is selected on the properties cannot calculate the range of target function block, the applicable specification range of step is the target program file.  
 Applying function blocks to locations where instances are used ( Section 4.3.2)  
When the last row of function block is selected, the last step number indicates not the last step of function block but the last step of call source program.
-





# 13 USING USER LIBRARIES

In Structured project, user libraries are shared among multiple projects as program assets. This chapter explains the user library operating methods.

13.1	Procedure for Using User Library	13 - 2
13.2	Creating User Library	13 - 3
13.3	Using User Library	13 - 10

SEARCHING FOR SPECIFIC POSITION	9
CONVERTING/COMPILING PROGRAMS	10
WRITING/READING DATA TO/FROM PROGRAMMABLE CONTROLLER CPU	11
MONITORING	12
<b>USING USER LIBRARIES</b>	<b>13</b>
SETTING OPTIONS	14
APPENDIX	A
INDEX	I

## 13.1 Procedure for Using User Library

Q CPU L CPU FX

This section explains how to create a user library.

POUs created in a user library can be shared among multiple projects.

The following explains how to utilize a created user library to other projects.

### Operating procedure

#### 1. Create a user library.

Procedure	Reference
Create a new user library.	Section 13.2.1
Create data for the user library.	Section 13.2.3
Save the user library under a specified name.	Section 13.2.4



#### 2. Utilize the library.

Procedure	Reference
Utilize the user library to a project.	Section 13.3.1
Create a program using the user library.	Section 13.3.2



#### 3. Edit the user library and update the library file data.

Procedure	Reference
Change the setting to enable or disable editing of the utilized user library data.	Section 13.3.3
Update the user library data.	Section 13.3.4

## 13.2 Creating User Library

Q CPU L CPU FX

This section explains how to create a user library.

### 13.2.1 Creating user libraries

Create a new user library.

Select the User Library view of the Navigation window and follow the operation below.

#### Screen display

Select [Project] ⇒ [Library] ⇒ [Create] (  ).

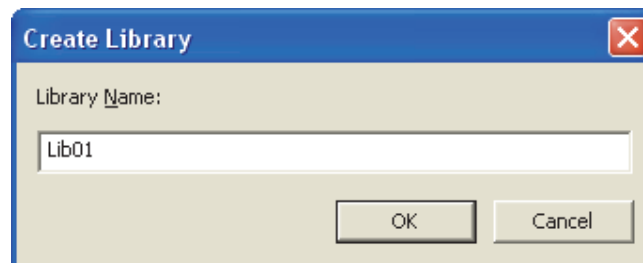

#### Operating procedure

1. Enter a library name.
2. Click the  button.

A user library is created and displayed on the User Library view.

#### Point

- **Maximum number of user libraries**  
The maximum number of user libraries that can be created in a project is 800.
- **Number of characters for a library name**  
The maximum number of characters that can be entered for a library name is 32.
- **Invalid characters for library names**  
For invalid characters for library names, refer to the following manual.  
 MELSEC-Q/L/F Structured Programming Manual (Fundamentals)

9

SEARCHING FOR  
SPECIFIC  
POSITION

10

CONVERTING/  
COMPILING  
PROGRAMS

11

WRITING/READING DATA  
TO/FROM PROGRAMMABLE  
CONTROLLER CPU

12

MONITORING

13

USING USER  
LIBRARIES

14

SETTING OPTIONS

A

APPENDIX

I

INDEX

## 13.2.2 Changing library name

---

Change the user library name.

### Operating procedure

1. **Select a library name to be renamed on the User Library view.**
2. **Select [Project] ⇒ [Library] ⇒ [Rename].**  
The editing of the library name on the project tree is enabled.
3. **Set the library name.**  
Press the  key to confirm the new library name.

## 13.2.3 Creating data

---

Create data for the user library.

### ■ Adding data

---

Add new data (programs, global labels, functions/function blocks, structures) to the user library.  
For details of adding new data, refer to the following manual.

 GX Works2 Version 1 Operating Manual (Common)

### Point

#### ● Global labels

- Labels defined in the global label setting on the User Library view can be used in the programs on the Project view.
- Labels defined in the global label setting on the Project view can also be used in the programs on the User Library view.
- The label names defined in the global label setting on the Project view and the User Library view cannot be overlapped.

#### ● System labels

Global labels on the Users Library view cannot be registered to the system label data base.

---

### ■ Editing data

---

Edit data (programs, global labels/local labels, functions/function blocks, structures).  
For details of editing data, refer to Chapter 5 through Chapter 8.

## 13.2.4 Saving library file

Save a user library to a library file.  
A library file can be also saved with a different library name.

### ■ Saving user library under specified name

Save the user library under a specified name.

#### Screen display

Select [Project] ⇒ [Library] ⇒ [Save As].

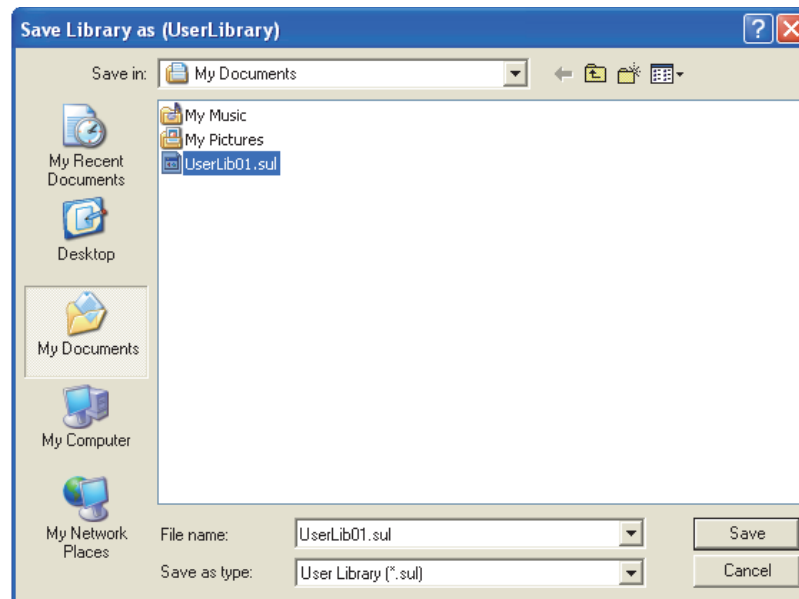

#### Operating procedure

1. Select a library name to be saved on the User Library view. (Multiple libraries can be selected.)
2. Select [Project] ⇒ [Library] ⇒ [Save As].  
The Save Library as screen is displayed.
3. Set a file name.
4. Click the **Save** button.  
The user library data are saved to the library file.

9

SEARCHING FOR  
SPECIFIC  
POSITION

10

CONVERTING/  
COMPILING  
PROGRAMS

11

WRITING/READING DATA  
TO/FROM PROGRAMMABLE  
CONTROLLER CPU

12

MONITORING

13

USING USER  
LIBRARIES

14

SETTING OPTIONS

A

APPENDIX

I

INDEX

## ■ Saving library files

---

Save the user library in the library file.

### Operating procedure

1. **Select a library name to be saved on the User Library view. (Multiple libraries can be selected.)**
2. **Select [Project] ⇒ [Library] ⇒ [Save].**

The user library data is saved in the library file.

### Point

#### ● Identifying the saved library file

A saved library file is identified with the path and file name which are specified when the file was saved with a specified name previously, or installed to the project.

Paths and file names can be checked in the property of user library.

#### ● Applying file changes to other projects

To apply the changes to library files in other projects, update the user libraries in each project in advance.

(☞ Section 13.3.4)

---

## 13.2.5 Deleting user library from project

Delete a user library from the project.

### Operating procedure

1. Select a library name to be deleted on the User Library view. (Multiple libraries can be selected.)
2. Select [Project] ⇒ [Library] ⇒ [Deinstall].  
The selected data is deleted.

### Point

#### ● Deleting user library

- The saved library file is not deleted even if a user library is deleted.
- All POUs using the deleted library file become in the uncompiled status. Compile the program again.

9  
SEARCHING FOR  
SPECIFIC  
POSITION

10  
CONVERTING/  
COMPILING  
PROGRAMS

11  
WRITING/READING DATA  
TO/FROM PROGRAMMABLE  
CONTROLLER CPU

12  
MONITORING

13  
USING USER  
LIBRARIES

14  
SETTING OPTIONS

A  
APPENDIX

I  
INDEX

## 13.2.6 Setting password to user library

Set a password to protect data in the user library.

Once the password is set, programs in the POU's are hidden on the screen. Structures, global labels, and local labels are displayed.

### Screen display

Select [Project] ⇒ [Library] ⇒ [Change Password].

### Operating procedure

#### 1. Set the items on the screen.

Item	Description
Library Name	Display a library name to which a password is set.
Password Setup	Set a password.
Old Password	Enter a previous password. Leave the field blank when setting a password for the first time.
New Password	Enter a new password.
Confirm Password	Re-enter a new password for confirmation.

#### 2. Click the button.

### Point

#### ● Password

Set a password within 14 characters using alphanumeric characters and symbols correspond to the ASCII code 20H to 7EH. For details of ASCII code, refer to the following manual.

 GX Works2 Version 1 Operating Manual (Common)

#### ● Libraries saved in library files

If a user library is saved in the library file, the password setting is also saved.

Library files must be managed carefully if they are shared with multiple projects.

#### ● Editing status

Before using this function, enable the editing of the user library. ( Section 13.3.3)



## 13.2.7 Set help file to library

Set a help file to the library.

Specified files created in the following formats can be set as help data.

- Windows® help file (\*.hlp)
- HTML help file (\*.chm)
- Text file (\*.txt)

The path to the help file can be changed regardless of the editing status of library.

### Operating procedure

1. Select a user library to which a property is set, and select [Project] ⇒ [Object] ⇒ [Property] (  ).

The Property screen is displayed.

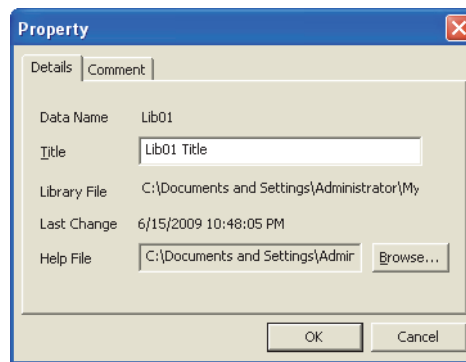

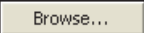
2. Click the  button.

The Open a help file screen is displayed.

3. Select a file to be set.

The path and name of the selected help file are displayed on the Property screen.

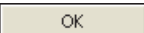
4. Click the  button.

The specified help file is set as the user library help.

9

SEARCHING FOR  
SPECIFIC  
POSITION

10

CONVERTING/  
COMPILING  
PROGRAMS

11

WRITING/READING DATA  
TO/FROM PROGRAMMABLE  
CONTROLLER CPU

12

MONITORING

13

USING USER  
LIBRARIES

14

SETTING OPTIONS

A

APPENDIX

I

INDEX

## 13.3 Using User Library

Q CPU L CPU FX

This section explains how to use a created user library.

### 13.3.1 Installing user library data to project

Install user library data from the existing library file to the project.

#### Screen display

Select [Project] ⇒ [Library] ⇒ [Install].

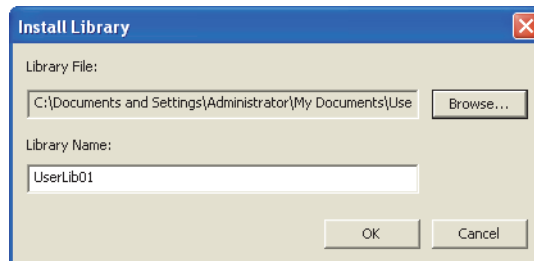

#### Operating procedure

##### 1. Set the items on the screen.

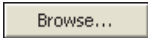
Item	Description
Library File	Set a path of the library file to be installed. Click the  button, and select a folder on the <u>Open Library</u> screen.
Library Name	Enter a library name.

##### 2. Click the button.

The selected library file data are installed and the library name is displayed on the User Library view.

The user library is in the editing disabled status after the data are installed. Enable the editing status of the user library for editing. (☞ Section 13.3.3)

**Point**

- **Maximum number of user libraries**

The maximum number of user libraries that can be created in a project is 800.

- **When the data name of the global label is duplicated between the library file to be installed and project**

The following screen is displayed when installing user library, and the data name of global label can be changed on the screen.

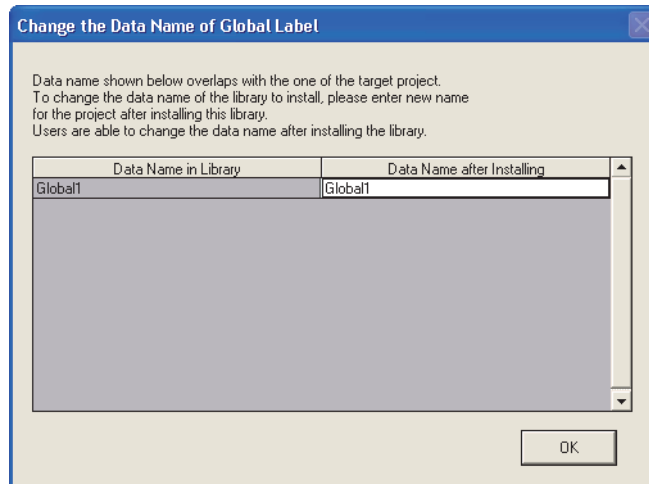

9

SEARCHING FOR  
SPECIFIC  
POSITION

10

CONVERTING/  
COMPILING  
PROGRAMS

11

WRITING/READING DATA  
TO/FROM PROGRAMMABLE  
CONTROLLER CPU

12

MONITORING

13

USING USER  
LIBRARIES

14

SETTING OPTIONS

A

APPENDIX

I

INDEX

## 13.3.2 Creating programs using user library

---

Use data in a user library to create programs in a project.

### ■ Using user library data: programs

---

Use programs in a user library by registering them to a task.  
For details of registering programs to a task, refer to Section 4.2.

### ■ Using user library data: global labels

---

Use global labels in a user library by selecting them in a program.  
For details of selecting global labels in a program, refer to Chapter 5.

### ■ Using user library data: functions/function blocks

---

Use functions/function blocks in a user library by selecting a user library for POU type on the Element Selection window.  
For details of using functions/function blocks, refer to Section 5.4.

### ■ Using user library data: structures

---

Use structures in a user library by setting them in each label setting editor.  
For details of using structures, refer to Section 5.6.

### 13.3.3 Editing user library

Edit installed user library data.

#### ■ Enabling editing of user library data

Enable the editing of user library data.

To edit user library data, the library needs to be set in the editing status.

#### Screen display

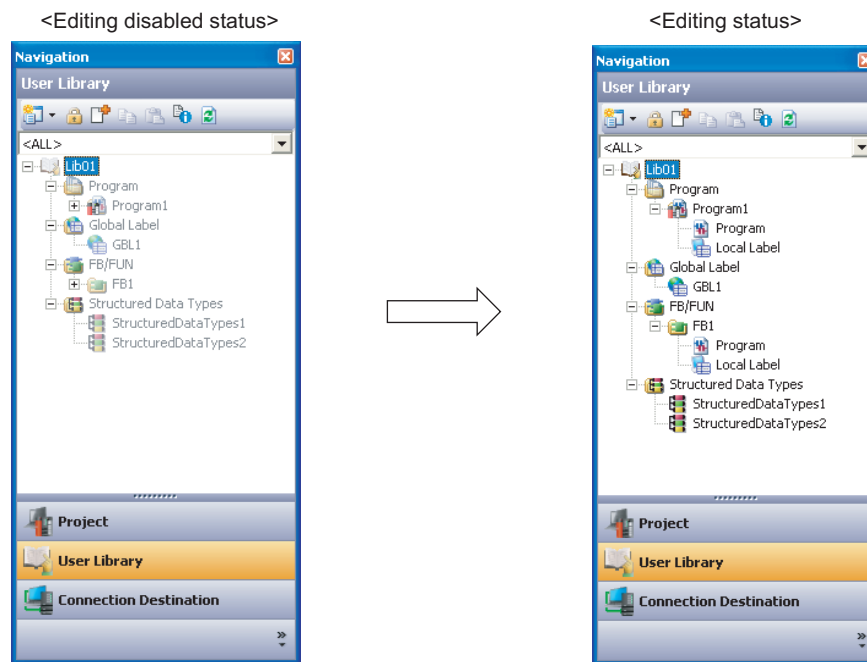

#### Operating procedure

1. Select a user library to be edited on the User Library view. (Multiple libraries can be selected.)
2. Select [Project] ⇒ [Library] ⇒ [Open] (  ).

The editing of the user library data is enabled.

- Library password

If the library is protected with a password, the password needs to be entered to open the library for editing.

When the password entry screen is displayed, enter the library password.

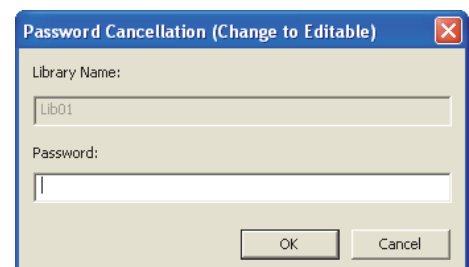

9

SEARCHING FOR  
SPECIFIC  
POSITION

10

CONVERTING/  
COMPILING  
PROGRAMS

11

WRITING READING DATA  
TO/FROM PROGRAMMABLE  
CONTROLLER CPU

12

MONITORING

13

USING USER  
LIBRARIES

14

SETTING OPTIONS

A

APPENDIX

I

INDEX

**Point**● **Editing status when opening a project**

When a project is opened, all libraries are in the editing disabled status.

(Even if a project is closed with the editing status, it is set in the editing disabled status when reopening the project.)

■ **Disabling editing of user library data**

Disable the editing of user library data.

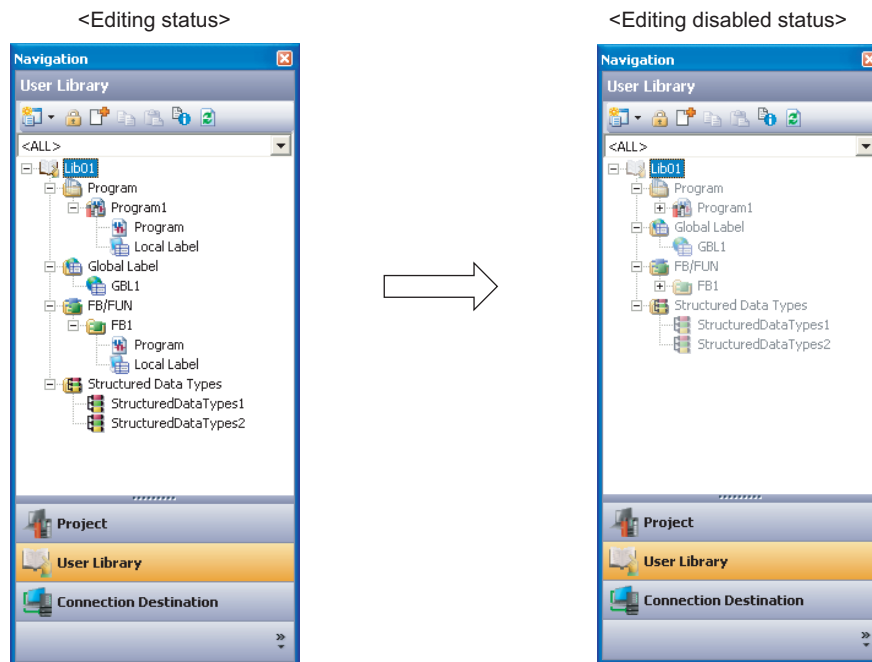
**Screen display****Operating procedure**

1. Select a user library to be edited on the User Library view. (Multiple libraries can be selected.)
2. Select [Project] ⇒ [Library] ⇒ [Close] (  ).

The editing of the user library data is disabled.

## 13.3.4 Updating user library

Update data in a user library file.

### Operating procedure

1. Select a library name to be updated on the User Library view. (Multiple libraries can be selected.)
2. Select [Project] ⇒ [Library] ⇒ [Reload].

The data in the library file is read and the display contents on the User Library view are refreshed.

To apply the library file changes made in another project (① in the figure below) to the current project, the user library needs to be updated (③ and ④ in the figure below).

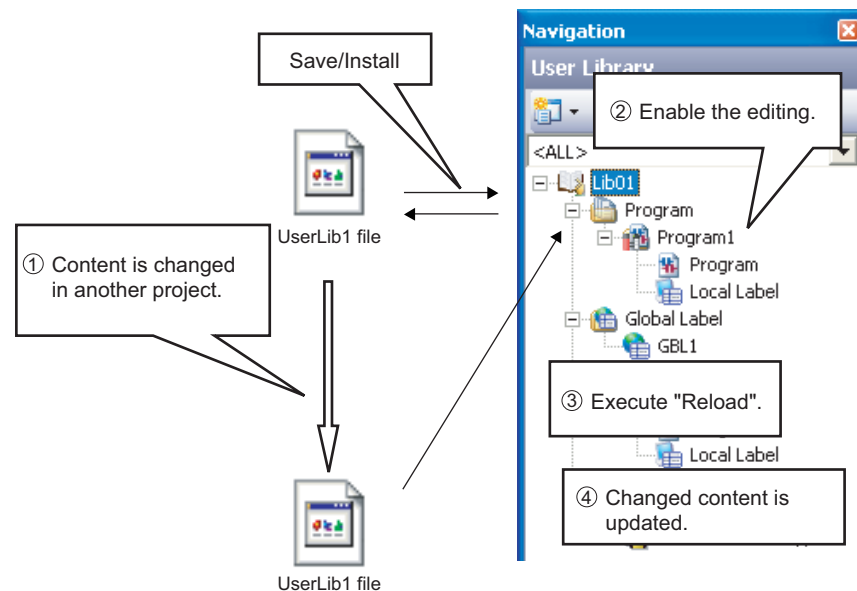

### Point

#### ● Compilation status of POUs

When a user library is updated, all POUs using the updated user library become in the uncompiled status.

#### ● Editing status

- Before using this function, enable the editing of the user library data. (☞ Section 13.3.3)
- When this function is completed, the editing of the user library data is disabled.

9

SEARCHING FOR  
SPECIFIC  
POSITION

10

CONVERTING/  
COMPILING  
PROGRAMS

11

WRITING/READING DATA  
TO/FROM PROGRAMMABLE  
CONTROLLER CPU

12

MONITORING

13

USING USER  
LIBRARIES

14

SETTING OPTIONS

A

APPENDIX

I

INDEX

### 13.3.5 Displaying user library help

Display a help set to a user library.

Specified files created in the following formats can be set as help data.

- Windows® help file (\*.hlp)
- HTML help file (\*.chm)
- Text file (\*.txt)

For setting a help, refer to Section 13.2.7.

#### Screen display

Select [Project] ⇒ [Library] ⇒ [Help].

Windows® help file (\*.hlp)

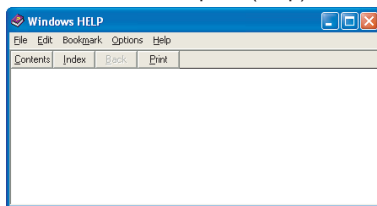

HTML help file (\*.chm)

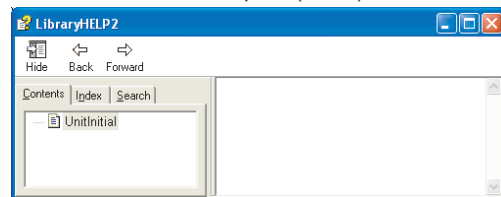

#### Operating procedure

1. Select a library name to be displayed as a library help on the User Library view.
2. Select [Project] ⇒ [Library] ⇒ [Help].  
A library help screen is displayed.

#### Point

##### ● Displaying help from utilized function blocks

The help set to the user library can be displayed from the utilized function blocks of the user library on the program. Select a function block on the program and press the **F1** key.





# 14 SETTING OPTIONS

This chapter explains the functions of options for setting screen display format or detailed operations of each function.

14.1	Basic Operations	14 - 2
14.2	Option Setting List	14 - 3

SEARCHING FOR SPECIFIC POSITION	9
CONVERTING/COMPILING PROGRAMS	10
WRITING/READING DATA TO/FROM PROGRAMMABLE CONTROLLER CPU	11
MONITORING	12
USING USER LIBRARIES	13
SETTING OPTIONS	14
APPENDIX	A
INDEX	I

## 14.1 Basic Operations

Q CPU L CPU FX

This section explains how to set options.

### Screen display

Select [Tool] ⇒ [Options].

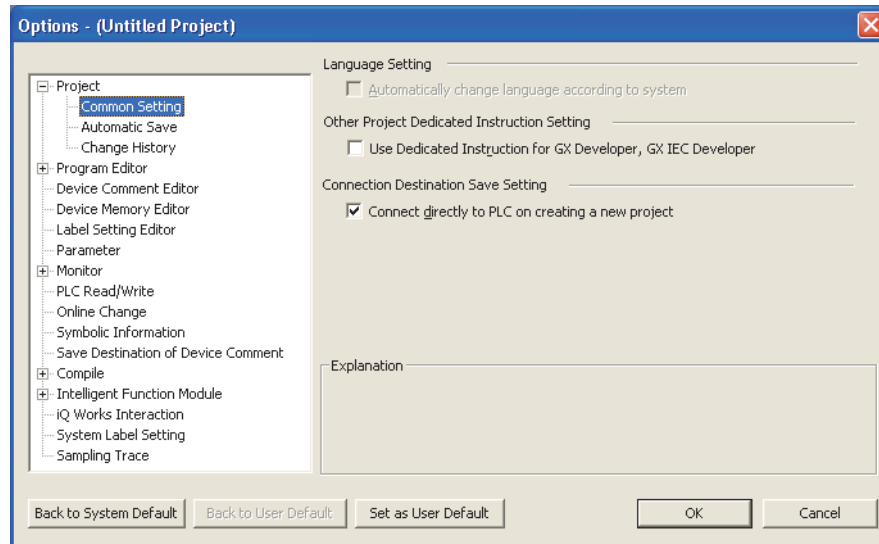

### Operating procedure

- **Set the items on the screen.**

When the cursor is placed on a setting item, an explanation of the item is displayed on the "Explanation" field.

Details of the setting items  Section 14.2

### Screen button

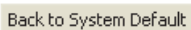
- 

Restores the initial settings.

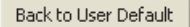
- 

Restores the user default settings.



- 

Stores the current settings as the user default and applies them to a new project.

# 14.2 Option Setting List

**Q CPU** **L CPU** **FX**

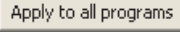
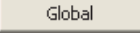
The following table shows the option setting items.  
 For the default setting of each item, refer to the following manual.  
 ➔ GX Works2 Version 1 Operating Manual (Common).

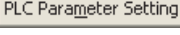
Tree item		Item	Explanation	Reference		
Project		➔ GX Works2 Version 1 Operating Manual (Common).				
Program Editor	All Editors	Device Comment	Program/Program File Name	Set a reference/reflection target of device comment of each program/program file.	(Common)	
			Specify the Reference/Reflection	Set a reference/reflection target according to the local device range of PLC parameter when set to "PLC parameter setting". Within the local device range: local device comment Outside the local device range: global device comment		
			Reference/reflect the other, when device comment is not set.	The behavior of each device will be as follows: (1) Global/Local comment will be referred. (2) If comment does not exist, the behavior will be: • specified to Global: refer Local Comment. • specified to Local: refer Global Comment.		
				Apply the current setting of reference/reflection target for device comment to all programs/program files.		
				Set all reference/reflection target to 'global' for device comment of selected program/program file name.		
				Set a all reference/reflection target to 'local' for device comment of selected program/program file name.		
				Set all reference/reflection targets for device comment of target device of the selected program/program file name to "PLC parameter setting". Target Device: Device can be specified within the local device range in the device setting of PLC parameter		
	Structured Ladder/FBD/ST	Tool Hint	Monitored Value	Select display item in tool hint when mouse cursor is placed over label/device name.		Section 6.2.8
			Class			
			Device			
			Address			
			Device Comment			
			Data Type			
			Constant Value			
Label Comment						
Remark						
Tool Hint Display Format			Select display lines on tool hint.			

SEARCHING FOR SPECIFIC POSITION	9
CONVERTING/COMPILING PROGRAMS	10
WRITING/READING DATA TO/FROM PROGRAMMABLE CONTROLLER CPU	11
MONITORING	12
USING USER LIBRARIES	13
SETTING OPTIONS	14
APPENDIX	A
INDEX	I

Tree item		Item	Explanation	Reference	
Program Editor	Structured Ladder/ FBD	Label	Display label name/ comment of contact or coil in multiline	Set display lines and characters per line.	Section 8.7.1
			Device	Select whether to display the device which is assigned to the label or corresponding to address at the same time when 'Label' is selected from View mode. * Users can neither edit the displayed device nor set them to the Find/Replace target at the same time.	Section 8.7.5
			Address	Select whether to display the address which is assigned to the label or corresponding to device at the same time when 'Label' is selected from View mode. * Users can neither edit the displayed address nor set them to the Find/Replace target at the same time.	
			Label Comment	Select whether to display the label comment which is assigned to the label at the same time when 'Label' is selected from View mode. * Users can neither edit the displayed label comment nor set them to the Find/Replace target at the same time.	
			Device Comment	Select whether to display device comment which is assigned to device or address when 'Label' is selected from View mode. Cannot display device comment which is assigned to label while using label. * Users can neither edit the displayed device comment nor set them to the Find/Replace target at the same time.	
			Declare new label name	Select whether to display label registration/ selection dialog when entering new labels.	Section 8.2.2
		FB/FUN	Wrap instance name for function block	Select whether to wrap function block instance name at the function block width.	Section 8.7.2
			Specify the number of enable characters for label name/comment	Specify the number of display characters of function or function block label.	Section 8.7.3
			Automatic input/output labels	Select whether to add input/output label when function block or function is pasted.	Section 8.6.1
			Automatic ENO labels	Select whether to add ENO output label when function block or function is pasted.	
	Add Automatic Output Variable to VAR_IN_OUT		Select whether to add output variable in VAR_IN_OUT when function block is pasted.		
	Pin overwrites		Select whether to overwrite I/O label with a grid line when ruling a grid line over function or function block.	Section 8.3.2	
	Double clicking opens header		Select whether a label editor is displayed when function or function block is double clicked.	Section 6.2.9	
	Double clicking opens body	Select whether a program editor is displayed when function or function block is double clicked.			

Tree item		Item	Explanation	Reference
Program Editor	Structured Ladder/ FBD	Guided	Ladder Wrapping	Select whether to wrap ladder. The edited ladder shall be object after changing the setting.
			Return Contacts	
			Open Structured Ladder/ FBD Editor in guided mode	Set the default at opening structured ladder/FBD editor as guided mode.
			Allow hotkey repeater	Select whether to display grid line ruling dialog at drawing lines.
			Enter label names after contacts and coils	Select whether to input label names or devices after entering contacts and coils.
			Auto Comment Block Width	Set the width of comment to be added in ladder block with grid numbers when adding ladder block.
	ST	Auto indentation	Select whether to use the automatic indent when beginning a new line after entering ST control syntax such as IF or FOR, and when displaying template of inline structured text.	Section 7.1.2
		Instruction/label name prediction	Select whether to display listed label names starting with the input character when a character is input.	Section 7.1.1
		Tabulator Length	Set tabulator length. It is not available with inline structured text.	Section 7.1.3
	Ladder/SFC	☞ GX Works2 Version 1 Operating Manual (Common)		
Ladder	☞ GX Works2 Version 1 Operating Manual (Simple Project)			
SFC				
Device Comment Editor	☞ GX Works2 Version 1 Operating Manual (Common)			
Device Memory Editor				
Label Setting Editor	Automatic copy and increment when inserting a row	Select whether to copy the texts in the upper row after incrementing it when inserting a row.	Section 5.5.5	
	Copy data type/comment items	Select if the data type, comment, and remark shall be object for auto copy.		
	Default Length of String Data Type	Set the default string length for string data type.	Section 5.5.3	
	Display last blank row	Select whether to display last blank row. This setting is valid for global label and local label except the local label of function block, function and structured data type.	Section 5.5.5	
Parameter	☞ GX Works2 Version 1 Operating Manual (Common)			

9	SEARCHING FOR SPECIFIC POSITION
10	CONVERTING/COMPILING PROGRAMS
11	WRITING/READING DATA TO/FROM PROGRAMMABLE CONTROLLER CPU
12	MONITORING
13	USING USER LIBRARIES
14	SETTING OPTIONS
A	APPENDIX
I	INDEX

Tree item		Item	Explanation	Reference
Monitor	Common	☞ GX Works2 Version 1 Operating Manual (Common)		
	Structured Ladder/FBD/ST	Display Format of Monitoring Value	Select whether to display monitored value in Decimal or Hexadecimal.	Section 12.3.1
		Monitor buffer memory and link direct device * Only applies to the QCPU, LCPU, FX3U(C)	Select whether to monitor buffer memory and link direct device during monitoring. Scan time of PLC will be lengthened depending on the setting.	-
		Significant Characters	Set the number of displayable characters to monitor character-string data.	Section 12.3.2
		Verify with PLC setting before starting monitoring	<ul style="list-style-type: none"> <li>When "Always Verify with PLC" is selected. Verify with PLC before starting monitoring. However, do not verify if simulator is running, selecting uncompiled program's POU, or unchanged POU (Last verification status is held while editor is open).</li> <li>When "Not Always Verify with PLC" is selected. Start monitoring without verifying with PLC.</li> <li>When "Confirm whether to Verify with PLC" is selected. Show a confirmation box whether to verify with PLC before starting monitoring. However, the confirmation box will not be displayed and do not verify if simulator is running, selecting uncompiled program's POU, or unchanged POU (Last verification status is held while editor is open).</li> </ul>	Section 12.1.1
	Ladder/SFC	☞ GX Works2 Version 1 Operating Manual (Common)		
	Ladder*1	☞ GX Works2 Version 1 Operating Manual (Simple Project)		
	SFC*1			
	PLC Read/Write	☞ GX Works2 Version 1 Operating Manual (Common)		
	Online Change*1			
Symbolic Information				
Save Destination of Device Comment				
Compile	Basic Setting	Enable calling function block and using inline ST	Enable calling function block from ladder to ST or vice versa, from ladder to Structured Ladder/FBD or vice versa, using inline ST in ladder, reducing steps when using function block. * Input label for VAR_IN_OUT remains equal to output label.	Section 4.4.1
		Do not execute duplicated coil check, ladder check and consistency (pair) check after Build or Online Program Change	Check when program check is not needed after Build or Online Program Change. It can reduce the compile time depending on the setting.	-
		Do not target the SET instruction for duplicated coil check	Select whether to set the SET instruction as the target for duplicated coil check.	Section 10.2
		Use the same label name in global label and local label	Select whether to use the same label name in global label and local label. When the same label is selected, local label will be given priority.	-
		Create cross reference information after completion compile.	Creating cross reference information after compiling enables to reduce find time. The information can be found in uncompiled project. Specified find condition is treated as filter condition. The setting will be canceled if find mode is 'Fast Find'.	(Common)

Tree item		Item	Explanation	Reference	
Compile	Output Result	Stop Build	Set the number of error and warning to stop the compile.	Section 10.4.1	
		Disable Warning and Notification Message	Register warning codes to invalidate. The registered warning codes shall not be displayed in output window.	Section 10.4.2	
		Display the Use Status Notification of Automatic-Assign Device in Output Result	The use status of device automatic-assign is displayed in output window.	-	
	Structured Ladder/ FBD/ST	Compile Condition 1	Use lower-case device names as labels*2	Select whether to use device names typed with lower case as labels. Only the device name outside device range is valid for Inline Structured Text.	Section 10.4.4
			Function Output Setting	Select whether to connect directly from the objective function output to other input.	Section 10.4.5
			Allow VAR_OUTPUT at FB call (ST)	Select whether to allow VAR_OUTPUT at FB call. Check: Able to specify VAR_OUTPUT as FB argument. (e.g. FBInst(FBVarOUT:=Variable);) Uncheck: Compile error C8015 returns if VAR_OUTPUT is specified as FB argument.	Section 10.4.6
			Add temporary variables as arguments to use macrocode	For FB call of ST or structured ladder from structured ladder, set whether to add temporary variables to input, I/O, or output argument to use macrocode.* Unable to add them depending on the programming language. Please refer to the appropriate manual.	Section 10.4.7
		Compile Condition 2	(D)INT_TO_BOOL_E, (D)WORD_TO_BOOL_E, TIME_TO_BOOL_E	Check the box to generate code that holds the output (SET). When unchecked, the instruction word output will be treated as a coil (OUT).	Section 10.4.9
			NOT_E		
			LIMITAION_E, MAXIMUM_E, MINIMUM_E		
EQ_E, NE_E, GT_E, GE_E, LT_E, LE_E					
AND_E, OR_E, XOR_E					
Compile Condition 3		User Defined Function with EN/ENO	Select whether to generate a code which keeps bit type output of the target function. (Codes keeping bit type are generated if output is in bit type array or in structure array, regardless of option setting.)	Section 10.4.8	
	User Defined Function Block with EN/ENO	Select whether to generate a code which keeps bit type output of the target function block. (Codes keeping bit type are generated if output is in bit type array or in structure array, regardless of option setting.)			
Intelligent Function Module*1		☞ GX Works2 Version 1 Operating Manual (Intelligent Function Module)			
IQ Works Interaction		☞ GX Works2 Version 1 Operating Manual (Common)			

9	SEARCHING FOR SPECIFIC POSITION
10	CONVERTING/COMPILING PROGRAMS
11	WRITING/READING DATA TO/FROM PROGRAMMABLE CONTROLLER CPU
12	MONITORING
13	USING USER LIBRARIES
14	SETTING OPTIONS
A	APPENDIX
I	INDEX

Tree item	Item	Explanation	Reference
System Label Setting*3	Use MELSOFT Navigator Option Information	Checking this option enables use of the option setting of MELSOFT Navigator. The option setting specified in MELSOFT Navigator at the time of opening this project is used.	Section 5.2
	System Label Name Setting	Set how to name system labels. When system labels are entered, system label names are determined based on this setting at the time of project save.	
Sampling Trace	 GX Works2 Version 1 Operating Manual (Common)		

\*1 : Not supported by FXCPU.

\*2 : Not supported by Simple project.

\*3 : For FXCPU, this item is supported by FX3S, FX3G, FX3GC, FX3U, and FX3UC only.





# APPENDIX

Appendix 1 List of Toolbars and Shortcut Keys

App - 2

SEARCHING FOR SPECIFIC POSITION	9
CONVERTING/COMPILING PROGRAMS	10
WRITING/READING DATA TO/FROM PROGRAMMABLE CONTROLLER CPU	11
MONITORING	12
USING USER LIBRARIES	13
SETTING OPTIONS	14
APPENDIX	A
INDEX	I

## Appendix 1 List of Toolbars and Shortcut Keys

Q CPU L CPU FX

This section shows the list of toolbars and shortcut keys that can be used in Structured project. For details of functions which are not described in this section, refer to the following manual.

☞ GX Works2 Version 1 Operating Manual (Common)

For "(Common)", "(FB)", indicated in the Reference column, refer to the following manuals respectively:















(Common) ... GX Works2 Version 1 Operating Manual (Common)  
 (FB) ... GX Works2 Version 1 Operating Manual (Simple Project, Function Block)

### Appendix 1.1 Common toolbars and shortcut keys

The following explains the toolbars that are available regardless of the editing target and the corresponding shortcut keys.



#### ■ "Program Common" toolbar icons

The following table shows the "Program Common" toolbar icons and the corresponding shortcut keys.

Toolbar icon	Shortcut key	Corresponding menu	Description	Reference
	<b>Ctrl</b> + <b>X</b>	Cut	Cut the selected data.	-
	<b>Ctrl</b> + <b>C</b>	Copy	Copy the selected data.	
	<b>Ctrl</b> + <b>V</b>	Paste	Paste the cut/copied data at the cursor position.	
	<b>Ctrl</b> + <b>Z</b>	Undo	Cancel the previous operation.	Section 6.2.3
	<b>Ctrl</b> + <b>Y</b>	Redo	Perform the operation canceled by [Undo].	
	-	Write to PLC	Write data to the programmable controller CPU.	Section 11.1
	-	Read from PLC	Read data from the programmable controller CPU.	
	-	Start Monitoring (All Windows)	Start monitoring all windows being opened.	(Common)
	-	Stop Monitoring (All Windows)	Stop monitoring all windows being opened.	
	<b>F3</b>	Start Monitoring	Start monitoring the window being operated.	Section 12.1
	<b>Alt</b> + <b>F3</b>	Stop Monitoring	Stop monitoring the window being operated.	
	<b>F4</b>	Build	Convert/compile the program being edited.	Section 10.1
	<b>Shift</b> + <b>F4</b>	Online Program Change	Convert/compile a sequence program and write it to the programmable controller CPU.	(Common)
	<b>Shift</b> + <b>Alt</b> + <b>F4</b>	Rebuild All	Compile/convert all programs in the project.	Section 10.2





## ■ "Docking Window/Switch Project Data" toolbar icons

The following table shows the "Docking Window/Switch Project Data" toolbar icons.

Toolbar icon	Shortcut key	Corresponding menu	Description	Reference
	-	Navigation	Display/hide the Navigation window.	(Common)
	-	Element Selection	Display/hide the Element Selection window.	Section 6.2.1
	-	Output	Display/hide the Output window.	Section 10.6

## ■ Other shortcut keys

The following table shows other shortcut keys that are available regardless of the editing target.

Toolbar icon	Shortcut key	Corresponding menu	Description	Reference
-		Rename Rename (Library)	Change the name of the selected data or library on the Navigation window.	(Common) Section 13.2.2
-		Delete	Delete the selected data.	(Common)
-		Copy	Copy data in the project.	
-		Paste	Paste the copied data to a folder.	









SEARCHING FOR SPECIFIC POSITION	9
CONVERTING/COMPILING PROGRAMS	10
WRITING/READING DATA TO/FROM PROGRAMMABLE CONTROLLER CPU	11
MONITORING	12
USING USER LIBRARIES	13
SETTING OPTIONS	14
APPENDIX	A
INDEX	I

## Appendix 1.2 Toolbar icons and shortcut keys for setting labels

The following explains the toolbar icons and the corresponding shortcut keys used for setting labels.

### ■ "Label" toolbar icons

The following table shows the "Label" toolbar icons and the corresponding shortcut keys.

Toolbar icon	Shortcut key	Corresponding menu	Description	Reference
	Shift + Insert	New Declaration (Before)	Add a row above the cursor position.	Section 5.5.5
	-	New Declaration (After)	Add a row below the cursor position.	
	Shift + Delete	Delete Row	Delete the row at the cursor position.	
	-	Read from CSV File	Read label settings from the CSV file.	Section 5.9
	-	Write to CSV File	Write label settings to the CSV file.	
	-	Confirm Update of System Label Database	Apply system label information changed in another project to global labels.	Section 5.2
	-	Import System Label	Import system label information and apply it to global labels.	
	-	Reservation to Register System Label	Reserve the selected global label for registration as a system label.	
	-	Reservation to Release System Label	Reserve the selected global label for deregistration of system label.	

### ■ Other shortcut keys

The following table shows other shortcut keys for setting labels.

Toolbar icon	Shortcut key	Corresponding menu	Description	Reference
-	Ctrl + A	Select All	Select all rows.	Section 5.5.5
-	Ctrl + ↑ / Ctrl + Num ↑ *1	-	Display all lines of comment and remark of the selected line.	
-	Ctrl + ↓ / Ctrl + Num ↓ *1	-	Display only the first line of comment and remark of the selected line.	













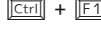



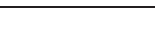







\*1 : 'Num' indicates keys in the numeric keypad.

## Appendix 1.3 Toolbar icons and shortcut keys for program editors

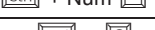
The following explains the toolbar icons and the corresponding shortcut keys for program editors.

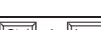
### ■ "ST" toolbar icons and shortcut keys

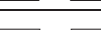
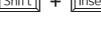





























The following table shows the toolbar icons and the corresponding shortcut keys for the ST editor.

Toolbar icon	Shortcut key	Corresponding menu	Description	Reference
		List Operands	Display the <u>Label Registration/Selection</u> screen.	Section 6.2.2
		Display Template	Insert a template corresponds to the instruction/function/control syntax.	Section 7.1.4
		Mark Template (Left)	Set an argument of the template in the selected status from the left by selecting the menu each time.	
		Mark Template (Right)	Set an argument of the template in the selected status from the right by selecting the menu each time.	
		Toggle Bookmark	Set a bookmark at the cursor line. If a bookmark has already been set, delete the set bookmark.	
	-	Bookmark List	Jump to the specified bookmark from the bookmark list.	Section 9.1.2
		Next Bookmark	Display the next bookmark position.	
		Previous Bookmark	Display the previous bookmark position.	
		Delete All Bookmarks	Delete all bookmarks.	
	 *1	Increase Zoom	Zoom in the screen one level.	Section 6.2.4
	 *1	Decrease Zoom	Zoom out the screen one level.	
-		Jump	Jump to the specified line.	Section 9.1.1
-		Zoom Header/Body/Header	Open the label setting editor of the selected POU.	Section 6.2.9
-		Copy	Copy the selected data.	-
-		Cut	Cut the selected data.	-
-		Paste	Paste the cut/copied data at the cursor position.	-
-		-	Display the instruction help of GX Works2 help or the help of the user library.	(Common) (FB) Section 13.3.5
-		-	Enter an assignment operator (:=) when editing the inline structured text program.	Section 7.1.1

\*1 : 'Num' indicates keys in the numeric keypad.

## ■ "Structured Ladder/FBD" toolbar icons and shortcut keys

The following table shows the toolbar icons and the corresponding shortcut keys for the Structured Ladder/FBD editor.

Toolbar icon	Shortcut key	Corresponding menu	Description	Reference	
	<b>Ctrl</b> + <b>Q</b>	Select Mode	Change the input mode for positioning contacts/coils.	Section 8.4	
	<b>Ctrl</b> + <b>I</b>	Interconnect Mode	Change the input mode for drawing lines.	Section 8.3.2	
	<b>Ctrl</b> + <b>Shift</b> + <b>Q</b>	Guided Mode/Guided Editing	Change the input mode for entry with keyboard.	Section 8.10	
	<b>Ctrl</b> + <b>Shift</b> + <b>A</b>	Guided Mode/Auto Comment	Add a comment entry field at the start of the ladder block added in Guided editing.	Section 8.10.9	
	<b>Ctrl</b> + <b>B</b>	Auto Connect	Connect the start and end points to draw a line automatically.	Section 8.3.3	
	<b>Ctrl</b> + <b>W</b>	Insert Row	Insert a row in the ladder program being edited.	Section 8.3.6	
	<b>Ctrl</b> + <b>U</b>	Insert Column	Insert a column in the ladder program being edited.		
	<b>Ctrl</b> + <b>Alt</b> + <b>B</b>	New Ladder Block Before	Insert a new ladder block in front of the ladder block being edited.	Section 8.8	
	<b>Ctrl</b> + <b>Alt</b> + <b>A</b>	New Ladder Block After	Insert a new ladder block in back of the ladder block being edited.		
	-	Input Instruction	Open the <u>Input Instruction</u> screen.	Section 8.2.2	
	-	Left Power Rail	Display/hide the left power rail.	Section 8.8.7	
	<b>1</b>	Open Contact	Insert an open contact at the cursor position.	Section 8.2.1	
	<b>2</b>	Close Contact	Insert a closed contact at the cursor position.		
	<b>3</b>	Open Branch	Insert an open contact branch at the cursor position.		
	<b>4</b>	Close Branch	Insert a closed contact branch at the cursor position.		
	<b>5</b>	Vertical Line Segment	Insert a vertical line at the cursor position.		
	<b>6</b>	Horizontal Line Segment	Insert a horizontal line at the cursor position.		
	<b>7</b>	Coil	Insert a coil at the cursor position.		
	<b>8</b>	Element Selection	Display the Element Selection window.		
	<b>9</b>	Input Label	Insert an input variable at the cursor position.		
	<b>0</b>	Output Label	Insert an output variable at the cursor position.		
	-	Rising Pulse	Insert a rising pulse at the cursor position.		
	-	Falling Pulse	Insert a falling pulse at the cursor position.		
	-	Rising Pulse Close	Insert a rising pulse close at the cursor position.		
	-	Falling Pulse Close	Insert a falling pulse close at the cursor position.		
	<b>Ctrl</b> + <b>J</b>	Jump	Insert a jump at the cursor position.		
	<b>Ctrl</b> + <b>R</b>	Return	Insert a return at the cursor position.		
	<b>Ctrl</b> + <b>M</b>	Comment	Insert a comment entry field.		
	<b>Ctrl</b> + <b>Shift</b> + <b>L</b>	Ladder Block Label	Display the <u>Ladder Block</u> screen.		Section 8.8.4
	<b>F2</b>	List Operands	Display the <u>Label Registration/Selection</u> screen.		Section 6.2.2





























Toolbar icon	Shortcut key	Corresponding menu	Description	Reference
		Increment Pins	Increment the number of arguments of functions and function blocks.	Section 8.6.3
		Delete Pins	Delete the number of arguments of functions and function blocks.	
		Increase Zoom	Zoom in the screen one level.	Section 6.2.4
		Decrease Zoom	Zoom out the screen one level.	
-		-	Narrow and widen the width of ladder block in the guided mode.	-
-		Signal Configuration/ Configure	Set the type of contact and coil.	Section 8.5
-		Signal Configuration/Toggle	Change the type of contact and coil in the order shown below: Contact: Open Contact → Close Contact Coil: Normal → Negation → Set → Reset	
-		Jump	Jump to the specified ladder block number.	Section 9.2.1
-		Change Label-Device- Address Mode	Switch the display format in order (label, device address).	Section 8.7
-		Change Label-Comment Mode	Switch the display between label and comment.	
-		Zoom Header/Body/Header	Open the label setting editor of the selected POU.	Section 6.2.9
-		Copy	Copy the selected data.	-
-		Cut	Cut the selected data.	-
-		Paste	Paste the cut/copied data at the cursor position.	-
-		Guided Mode /Overwrite, Insert Mode	Switch the input mode between Overwrite/ Insert in the guided mode.	Section 8.10
-		Guided Mode/Line Mode	Change the input mode for drawing lines in Guided editing.	
-		-	Scroll a ladder block to the right.	-
-		-	Scroll a ladder block to the left.	
-		-	Display the instruction help of GX Works2 help or the help of the user library.	(Common) Section 13.3.5

\*1 : 'Num' indicates keys in the numeric keypad.

9	SEARCHING FOR SPECIFIC POSITION
10	CONVERTING/COMPILING PROGRAMS
11	WRITING/READING DATA TO/FROM PROGRAMMABLE CONTROLLER CPU
12	MONITORING
13	USING USER LIBRARIES
14	SETTING OPTIONS
A	APPENDIX
I	INDEX

## Other shortcut keys

The following table shows other shortcut keys for program editors.

Toolbar icon	Shortcut key	Corresponding menu	Description	Reference
-	 /  /  / 	-	Move the cursor in the arrow direction.	
-		-	Scroll up the screen.	
-		-	Scroll down the screen.	
-	 + 	-	Scroll the screen to the left.	
-	 + 	-	Scroll the screen to the right.	
-		-	Move the cursor to its leftmost position in the row.	
-		-	Move the cursor to its rightmost position in the row.	
-	 + 	-	Move the cursor to the start of the program.	
-	 + 	-	Move the cursor to the end of the program.	
-	 +  /  /  / 	-	Set a range.	
-	 +  + 	-	Select the range from the current position up to the start of the program.	
-	 +  + 	-	Select the range from the current position down to the end of the program.	
-		-	Delete the selected target.	





# INDEX

SEARCHING FOR SPECIFIC POSITION	9
CONVERTING/COMPILING PROGRAMS	10
WRITING/READING DATA TO/FROM PROGRAMMABLE CONTROLLER CPU	11
MONITORING	12
USING USER LIBRARIES	13
SETTING OPTIONS	14
APPENDIX	A
INDEX	—

**[A]**

address ..... 5-4, 8-23  
 array ..... 5-15  
 Auto connect ..... 8-8  
 Automatic-Assign ..... 5-31

**[B]**

bit specification of word device ..... 5-26  
 Bookmark ..... 9-2

**[C]**

Check Warning ..... 10-23  
 Class ..... 5-12  
 Close Contact ..... 8-4, 8-15  
 Coil ..... 8-4, 8-15  
 comment ..... 5-4, 5-8, 5-10, 5-18, 5-23, 6-4, 8-4  
 Common instruction ..... A-22, 6-5  
 Compile condition ..... 14-7  
 Contact ..... 8-15  
 CSV file ..... 5-34  
 current value display ..... 12-5  
 current values ..... 12-3

**[D]**

Data Type ..... 5-4, 5-13, 5-14  
 decimal and hexadecimal ..... 12-5  
 device ..... 8-23  
 device memory ..... 11-3  
 Device name ..... 5-26, 5-28  
 display format ..... 8-23  
 Displaying ..... 13-16  
 Docking window ..... 2-3

**[E]**

editing mode ..... 8-3  
 Element Selection Window ..... 2-3, 4-15, 6-5  
 elements ..... 8-4  
 Error ..... 10-6, 10-23  
 executing conditions ..... 4-7

**[F]**

FB ..... 4-2  
 FBD ..... 1-2  
 FUN ..... 4-2  
 function ..... 4-14, 6-3, 6-5, 8-18  
 function block ..... 4-14, 6-3, 6-5, 8-18

**[G]**

Global label ..... 5-3  
 grid ..... 8-33  
 Guided mode ..... 8-36

**[I]**

indentation ..... 7-3  
 Input Label ..... 8-4  
 input variable ..... 8-18  
 Instance ..... 4-15, 8-19, 8-22, 12-4

**[J]**

Jump ..... 9-2, 9-4

**[L]**

Label Name ..... 5-4, 5-8, 5-10  
 label setting ..... 5-2, 5-12  
 Labels ..... 5-2  
 ladder block header ..... 8-29  
 Ladder block label ..... 8-29  
 Ladder block title ..... 8-29  
 Ladder Diagram ..... 1-2  
 Ladder symbols ..... 8-4  
 Left power rail ..... 8-2  
 library help ..... 13-9  
 line ..... 8-8  
 link direct device ..... 14-6  
 List format ..... A-22, 6-13  
 Local label ..... 5-8, 5-10

**[M]**

menu bar ..... 2-3

**[N]**

Navigation window ..... 2-3  
 Negation ..... 8-15

**[O]**

Open Contact ..... 8-4, 8-15  
 Operator ..... 6-5  
 Output Label ..... 8-4  
 output variable ..... 8-18  
 Output window ..... 2-3, 10-2, 10-23

**[P]**

POUs ..... 4-10, 4-14  
 Priority ..... 4-8  
 Program ..... 6-2  
 Program blocks ..... 4-4, 4-14, 6-3  
 Program Configuration ..... 4-2  
 Program Editor ..... 6-2  
 program files ..... 4-3  
 Program Setting ..... 4-7  
 programming language ..... 1-2, 6-3  
 Project view ..... 2-3, 4-2  
 Property ..... 4-8, 4-11

**[R]**

reading symbolic information from programmable controller  
CPU .....11-5  
Reset .....8-15  
Return .....8-4

**[S]**

Select Mode .....8-4  
Set .....8-15  
SFC .....1-2, 6-3  
Shortcut key .....App-2  
Simple project .....A-22  
Special instruction .....A-22, 6-5  
ST .....1-2, 7-2  
ST editor .....6-5, 7-2  
Structure Device Setting screen .....5-26  
Structured Ladder .....1-2  
Structured Ladder/FBD .....8-2  
Structured Ladder/FBD editor .....6-5, 8-2  
Structured project .....1-2

**[T]**

tabulator .....7-4  
tasks .....4-3  
toolbar .....2-3, App-2  
tooltip .....6-14

**[U]**

user library .....13-2  
User Library view .....13-3

**[V]**

variable .....8-19, 8-21, 8-39

**[W]**

Warning .....10-6, 10-7  
Work window .....2-3  
writing symbolic information from programmable controller  
CPU .....11-5

SEARCHING FOR SPECIFIC POSITION	9
CONVERTING/COMPILING PROGRAMS	10
WRITING/READING DATA TO/FROM PROGRAMMABLE CONTROLLER CPU	11
MONITORING	12
USING USER LIBRARIES	13
SETTING OPTIONS	14
APPENDIX	A
INDEX	

Microsoft, Windows are trademarks or registered trademarks of Microsoft Corporation in the United States and other countries.

Ethernet is a trademark or registered trademark of Xerox Corporation.

All other company names and product names used in this manual are trademarks or registered trademarks of their respective companies.



SH(NA)-080781ENG-X(1503)KWIX

MODEL:GXW2-VER1-O-KP-E

MODEL CODE: 13JU65

## **MITSUBISHI ELECTRIC CORPORATION**

HEAD OFFICE : TOKYO BUILDING, 2-7-3 MARUNOUCHI, CHIYODA-KU, TOKYO 100-8310, JAPAN  
NAGOYA WORKS : 1-14, YADA-MINAMI 5-CHOME, HIGASHI-KU, NAGOYA, JAPAN

When exported from Japan, this manual does not require application to the  
Ministry of Economy, Trade and Industry for service transaction permission.

Specifications subject to change without notice.